



**Look** inside for Assembly Manual

Check us out!



[Littleseedskids.com](http://Littleseedskids.com)

# DL8947/ DL8947-GR ROCKER



Keep this Assembly Manual for future reference.

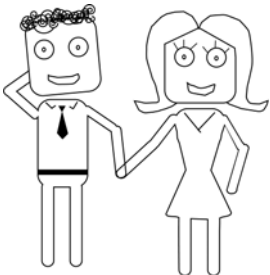
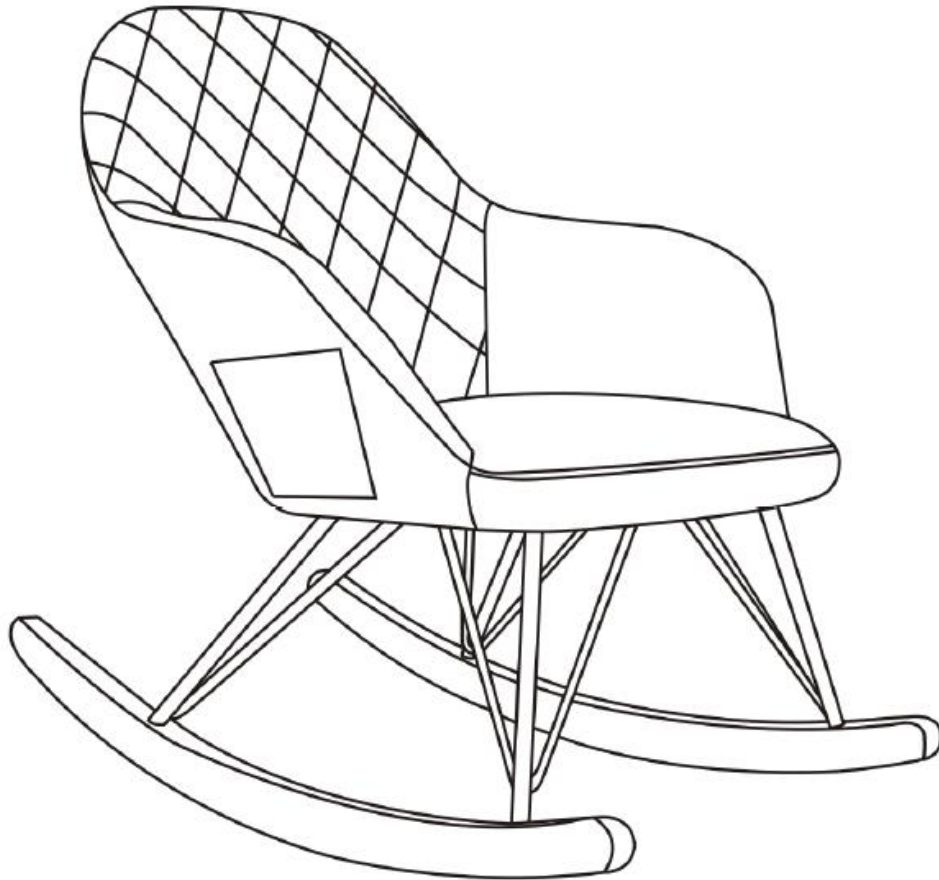

Two adults  
recommended  
for assembly

This product is not intended for commercial use.

Do NOT return this product.

- For missing or broken parts
- Visit [littleseedskids.com](http://littleseedskids.com)
  - Write to [cs@dhpffurniture.com](mailto:cs@dhpffurniture.com)
  - Call 1-800-267-1739

Follow little seeds on





---

## Do NOT return this product!

Contact our friendly customer service team first for help.

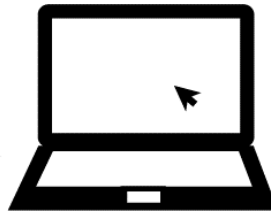
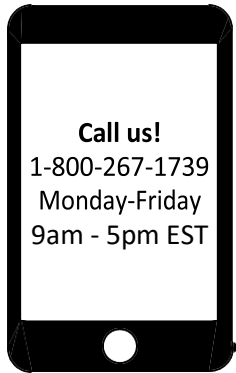

Visit [littleseedskids.com](http://littleseedskids.com) to view the limited warranty valid in the U.S. and Canada.

---

## Helpful Hints

PEOPLE NEEDED FOR ASSEMBLY: 1-2

ESTIMATED ASSEMBLY TIME: 1 HOUR

---

- Open your item in the area you plan to keep it for less heavy lifting.
- Identify, sort and count the parts before attempting assembly.
- Do Not use harsh chemicals or abrasive cleaners on this item.
- Never push, pull, or drag you furniture.
- Assemble on clean, smooth surface to prevent damage to product finish.
- Do Not use power tools.



# Before You Star

- ✓ Read through each step carefully and follow the proper order.
  - ✓ Separate and count all your parts and hardware.
  - ✓ Give yourself enough room for the assembly process.
- 

## Cleaning and Maintenance Instructions:

Dust regularly with a soft, dry cloth to prevent soil build up. Keep away from heat to avoid glazing, melting or scorching. Use a professional cleaning service to clean the fabric.

# Parts List

## Actual Size

①



BOLT  
4PCS

②

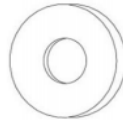

FLAT WASHER  
12PCS

③

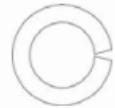

SPRING WASHER  
12PCS

④

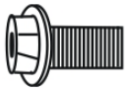

BOLT  
8PCS

⑤



ALLEN KEY  
1PC

## Not Actual Size

A.

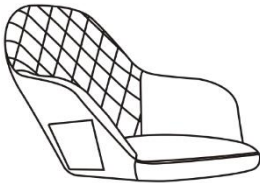

CHARI BODY  
1PC

B.

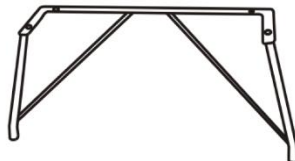

FRONT METAL LEG  
1PC

C.

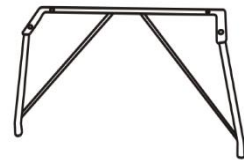

REAR METAL LEG  
1PC

D.



FOOT  
2PCS

# Step 1

Attach metal legs (B & C) to chair body (A) with bolts (4), flat washers (2) & spring washers (3). Use allen key (5) to tighten the bolts.

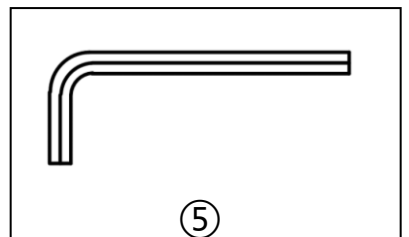
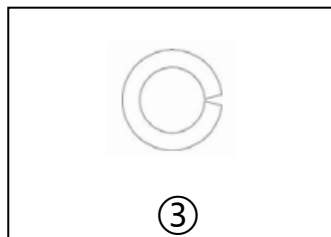
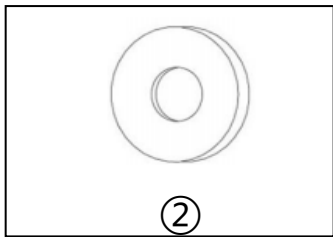
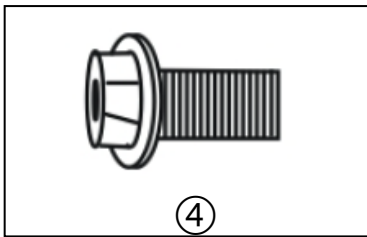
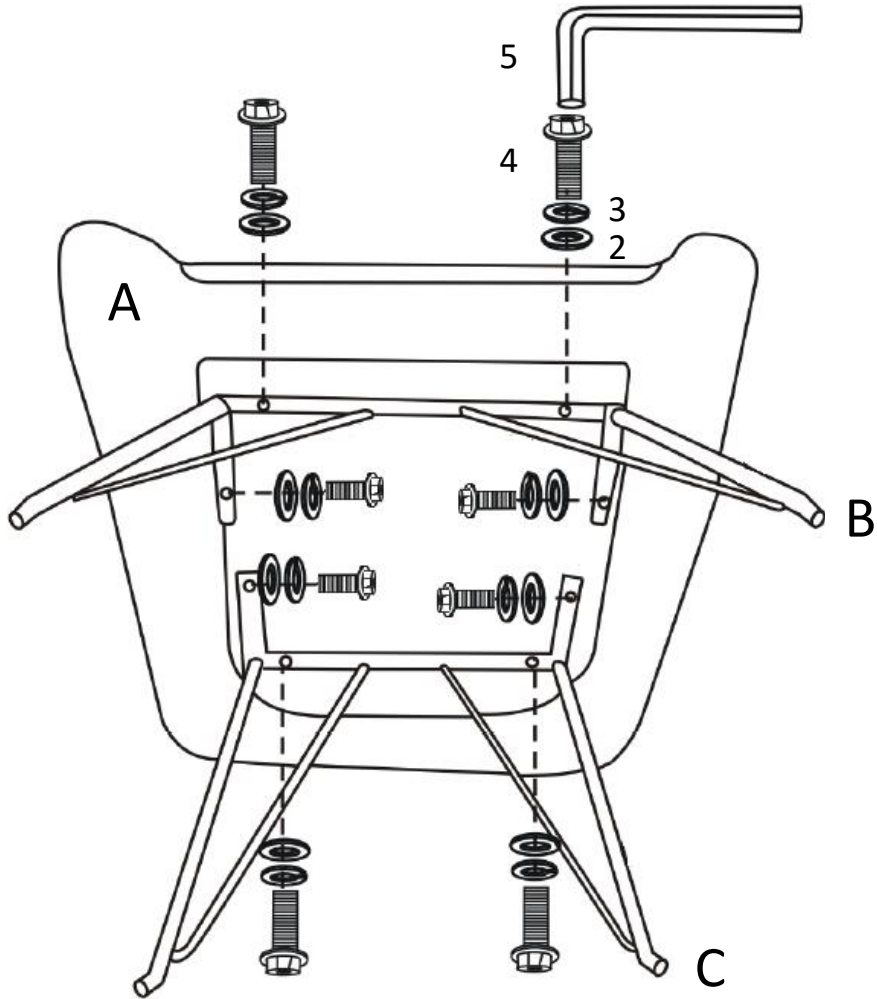

# Step 2

Attach feet (D) to metal legs (B & C) with flat washers (2), spring washers (3) and bolts (1). Use Allen key (5) to tighten the bolts. Turn the rocker upright.

