

LA CROSSE®
TECHNOLOGY

WI-FI PROJECTION
ALARM CLOCK
WITH  **AccuWeather** FORECAST
INSTRUCTION MANUAL



Welcome!

Congratulations on your new Projection Alarm Clock and welcome to the La Crosse Technology family! This product was designed with you in mind by our hometown team of weather enthusiasts based in La Crosse, Wisconsin.

Model: C8929
DC: 082318

TABLE OF CONTENTS

3	Setup	13	Settings Menu
4	Button Functions	14	Projection
4	Alarm Clock Icons	15	Alarm with Custom Snooze Time
5	Extra Sensor Area Icons	17	Nap Timer
6	Purchase and Add Sensors	17	Moon Phase
7	Connect to La Crosse View™ App	18	Indoor Comfort Statement
8	Benefits of Connecting to La Crosse View™	18	USB Charging Port
9	Enhanced Weather Forecasts w/La Crosse View™	19	Low Battery Indicators
9	Advanced Forecast & Chance Precipitation	19	Factory Restart Alarm Clock
9	AccuWeather HI/LO Temperatures	19	We're Here to Help!
10	Custom Data Streams	19	Care and Maintenance
11	Status Messages when Connected	20	Specifications
12	Features of Your Alarm Clock	20	Warranty and Support
12	Adjustable Backlight	21	FCC Statement
12	Auto Dim Backlight	21	Canada Statement

SETUP

1. Insert the power cord into your C82929 Alarm Clock. Remove the insulation tab from the CR2032 battery compartment found on the bottom of your alarm clock.
2. Remove the battery insulation tab installed on the bottom of the clock.
3. Download the La Crosse View™ App (App Store or Google Play)
- 4 Follow along with our instructional videos to connect your alarm clock to the app:
http://bit.ly/LaCrosseView_Support_Vid_01_1
http://bit.ly/LaCrosseView_Support_Vid_01_2

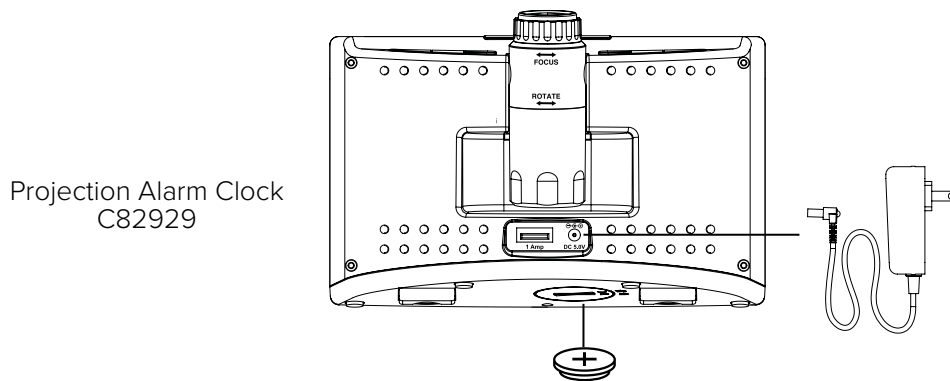

WARNING:

1. This product contains a Button Cell Battery.
2. If swallowed, it could cause severe injury or death in just 2 hours.
3. Seek medical attention immediately.

AVERTISSEMENT:

1. Cet article contient une pile bouton.
2. De graves blessures ou la mort pourraient suivre dans les deux heures suivant l'ingestion.
3. Demander l'aide de professionnels de la santé sur le champ.

WARNING - KEEP BATTERIES OUT OF REACH OF CHILDREN

1. Swallowing may lead to serious injury in as little as 2 hours or death, due to chemical burns and potential perforation of the oesophagus.
2. If you suspect your child has swallowed or inserted a button battery, immediately seek urgent medical assistance.
3. Examine devices and make sure the battery compartment is correctly secured, e.g. that the screw or other mechanical fastener is tightened. 4. Do not use if compartment is not secure.
5. Dispose of used button batteries immediately and safely. Flat batteries can still be dangerous.
6. Tell others about the risk associated with button batteries and how to keep their children safe.

BUTTON FUNCTIONS

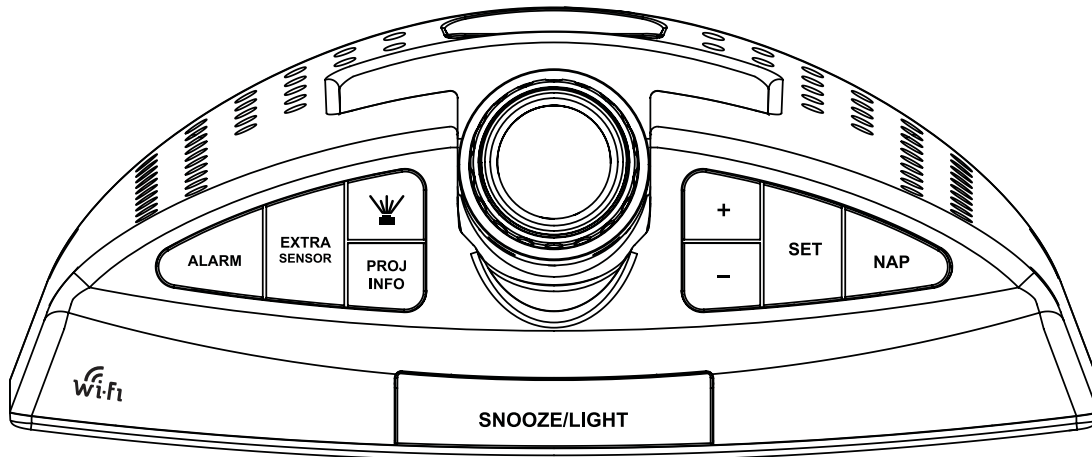

ALARM	Press to activate/deactivate alarm. Hold to set alarm.
EXTRA SENSOR	Press to see options. Hold to add sensors.
	Press to adjust projection brightness.
PROJ INFO	Press to see options. Hold to alternate.
+ or -	Press either to adjust value. Hold both to search for Wi-Fi signal.
SET	Press to view Wi-Fi Status. Hold for basic settings.
NAP	Press to start Nap countdown. Hold to set Nap time.
SNOOZE/LIGHT	Press to adjust backlight. Hold to set Auto Dim time.
ALARM + NAP	Hold both to Factory Reset Clock.

ALARM CLOCK ICONS

 **Wi-Fi Indicator:** Will flash when your alarm clock is ready to connect to the Internet, and be solid on screen when connected.

 **Internet Indicators:** Will display in areas to indicate data coming from the Internet.

 **Low Battery Indicator:** Will let you know when to replace your alarm's backup coin cell battery.

 **Alarm Indicator:** Indicates an active time alarm.



AUTO DIM: Indicatea the Auto Dim backlight feature is set.

12 HR 12HR: When connected to La Crosse View App, the Forecast replaces moon phase. his is a 12 hour forecast.



Forecast Icons: When connected to La Crosse View App, the Forecast replaces moon phase.



Precent of Precipitation: When connected to La Crosse View App, the Percent of Precipitation will show in the forecast area.

EXTRA SENSOR AREA ICONS

- The Extra Sensor area of your alarm clock will default to 30 NAP when you first power up.
- If you connect to the La Crosse View App you will see Internet Temperature.
- When you choose to add sensors, the Sensor Reception Indicator will show in the upper left corner whether 30 NAP or Sensor reading is displayed.
- Press and release the EXTRA SENSOR button to view all additional sensors.

Default Reading-Press EXTRA SENSOR button to toggle to Alarm Time



Low Battery Indicator



Sensor Reception



Probe Reading

Default Reading Connected- Press EXTRA SENSOR button to toggle to Alarm Time or Nap Duration



Added an Temperature/Humidity Sensor (not included) Press EXTRA SENSOR button to toggle to ll readings in this area.



PURCHASE AND ADD SENSORS

Optional Extra Sensors: Up to 4 additional Thermo-Hygro, Wind Speed, Rain, Water Leak or any combination of these sensors can read to the EXTRA SENSOR area of your display. Simply press and release the EXTRA SENSOR button to view these sensors.

Purchase Extra Sensors: For additional sensors to read to your alarm clock or to the app visit the **PARTS TAB** at: bit.ly/C82929

Note: Not all sensors will read to the alarm clock. Be sure to check the chart to see if a sensor can read to the app only, or both alarm clock (extra sensor area) and app.

Add Extra Sensors to your alarm clock:

1. Hold the EXTRA SENSOR button 3 seconds, to add a sensor to the alarm clock.
2. Install batteries in the sensor, and if the sensor has a TX button, press the TX button to force a signal.
3. Allow up to 3 minutes to view sensor and ID on alarm clock.

Note: Once sensor is found the search will stop. Sensor, ID, and type will show for 3 seconds then return to normal display.

4. Scan sensor bar code ID so it will read in the La Crosse View app.
5. Added sensors will be available for display in Extra Sensor area of alarm clock.

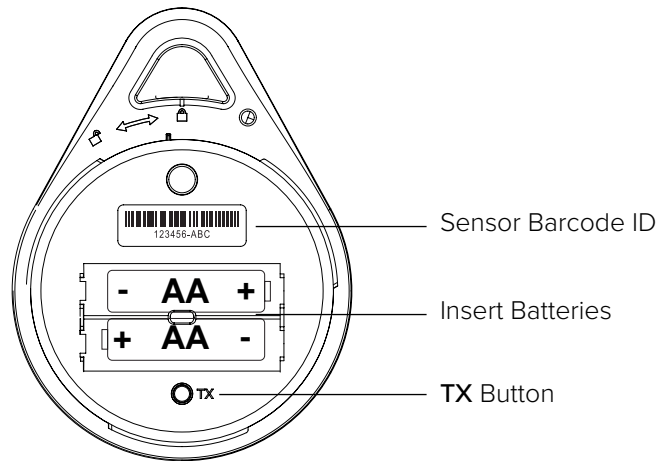

Basic alarm clock readings

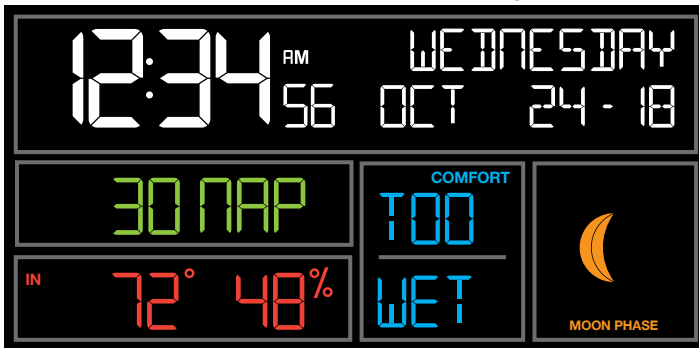

Basic alarm clock readings with Water Leak sensor.

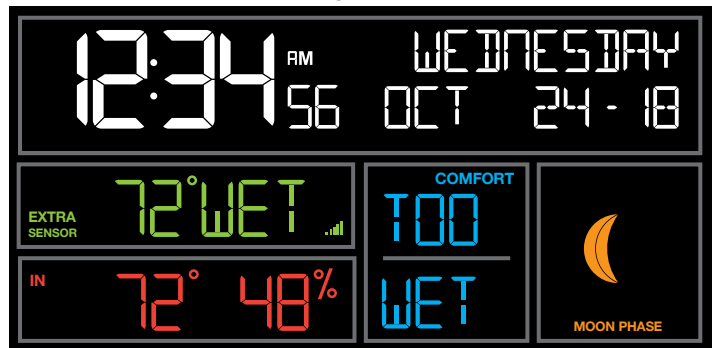

Delete Extra Sensors from your alarm clock:

1. Press and release the EXTRA SENSOR button until you see the sensor and ID you wish to delete.
2. Hold the MINUS (-) button for 3 seconds to delete this sensor. The sensor readings and ID will show dashes.
3. Sensor will no longer show in the Extra Sensor area.

CONNECT TO LA CROSSE VIEW™ APP

MOBILE DEVICE REQUIREMENTS

iOS Requirements:

Mobile device with iOS with cellular or Wi-Fi service

Android Requirements:

Mobile device with Android OS with cellular or Wi-Fi service

GET YOUR ALARM CLOCK READY

Ensure your alarm clock's Wi-Fi Indicator  is flashing. If it is not, press and hold the Plus (+) and Minus (-) buttons down together until it begins flashing. This tells you that your alarm clock is ready to connect.

CHECK YOUR NETWORK

Connect your mobile device (phone or tablet) to your router's 2.4GHz Wi-Fi network. For more Wi-Fi info visit: www.lacrossetechnology.com/router_info

DOWNLOAD

Visit the App Store or Google Play Store to download the free La Crosse View™ app onto your mobile device.



LAUNCH & FOLLOW

Open the La Crosse View™ app and follow the on-screen instructions.

When connecting your alarm clock we highly recommend following along with our detailed support videos, found here:

bit.ly/LaCrosseView_Support_Playlist

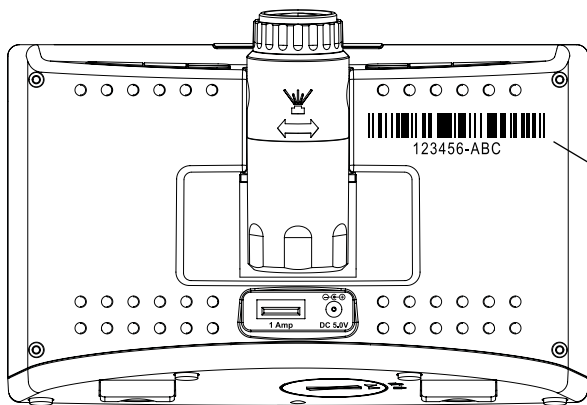

- Your alarm clock's device ID can be found on the back of the clock.
- Within 15 minutes after your alarm clock connects to the La Crosse View app, you should see the moon phase change to forecast, the indoor comfort change to HI/LO Temperature, Internet time/date set.

Alarm Clock Device ID



BENEFITS OF CONNECTING TO LA CROSSE VIEW™



Connecting You to Your Home **Anytime, Anywhere.**

FEATURES	STANDALONE	CONNECTED
Indoor Temperature	✓	✓
Indoor Humidity	✓	✓
Time Alarm	✓	✓
Moon Phase	✓	
Indoor Comfort Statement	✓	
Ability to Add Sensors	✓	✓
Internet Time and Calendar		✓
Advance Forecast Icons		✓
Internet Outdoor Temperature		✓
Daily Forecast HIs & LOs		✓
% Chance of Precipitation		✓
Data Stream Technology		✓
Remote Monitoring		✓
Set Alerts		✓
View Graphs		✓

ENHANCED LACROSSE VIEW CONNECTED FEATURES.

- Forecast Icons & Chance of Precipitation (12 Hour Forecast)
- AccuWeather HI/LO Temperatures
- Custom Data Streams

FORECAST & CHANCE OF PRECIPITATION

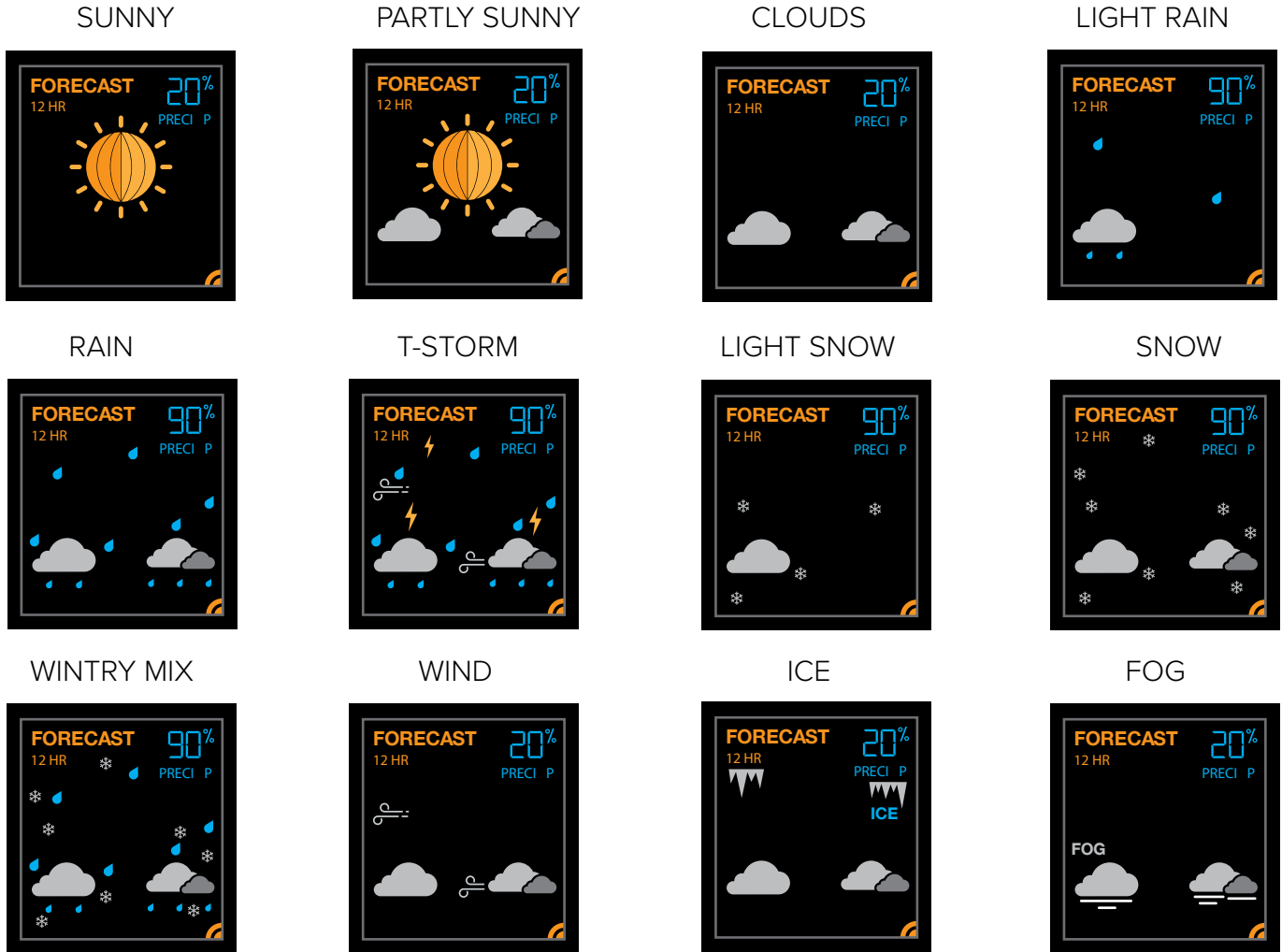

ACCUWEATHER HI/LO TEMPERATURE

Connected: HI/LO Temperature from Internet.



Not Connected: Indoor Comfort from Alarm Clock



IMPORTANT:

There may be small discrepancies between data displayed on your alarm clock and data shown through other AccuWeather services, such as their website and/or mobile app. This is common, as there are differences in the timing in which forecast data is fetched by these items. Our connected alarm clocks will receive forecast updates at least 4 times daily.

CUSTOM DATA STREAMS

Use the Data Stream Menu in the La Crosse View™ app to select up to 3 items to stream on your alarm clock.

1. Open the La Crosse View™ app and swipe until you find your alarm clock's device page. 
 2. Scroll down to the Data Stream section and press the blue stream icon in the upper right.
 3. Follow the app's instructions to customize your "Data Stream" to display on your alarm clock
- Note:** Allow up to 10 minutes for new Data Stream selections to appear on your alarm clock.

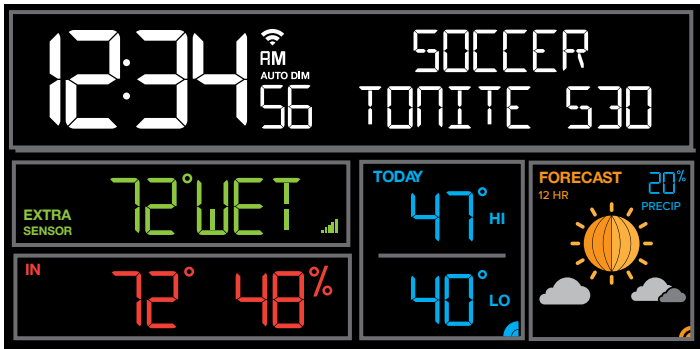

Custom Data Stream will alternate with Date

Data Stream Items:



Customizable Data Streams to enhance your in-home alarm clock:

Wind Speed • Wind Direction • Wind Gust • UV Index • Visibility • Dew Point • Percentage of Clouds • Sunrise Time • Sunset Time • Hours of Sunlight • Moon Rise Time • Moon Set Time • Temperature/Humidity • and more!

Personal Messages



Enter up to 20 characters for special events or reminders, such as:

- SOCCER TONIGHT • ICE CREAM IN FREEZER • GREAT JOB MATH TEST or anything you can think of!

Note: Allow up to 10 minutes for new Data Stream selections to appear on your alarm clock.

STATUS MESSAGES WHEN CONNECTED

Quick Tip:

- The Wi-Fi Icon  indicates Wi-Fi connection- not necessarily app connection.
- The Internet Icons  by your Forecast, Internet Temp (extra sensor area) and HI/LO Temperatures will indicate connection to the La Crosse View App and Weather Server.

Status Messages on you alarm clock will let you know if there are issues.
Press and release the SET button to view the status of your alarm clock.

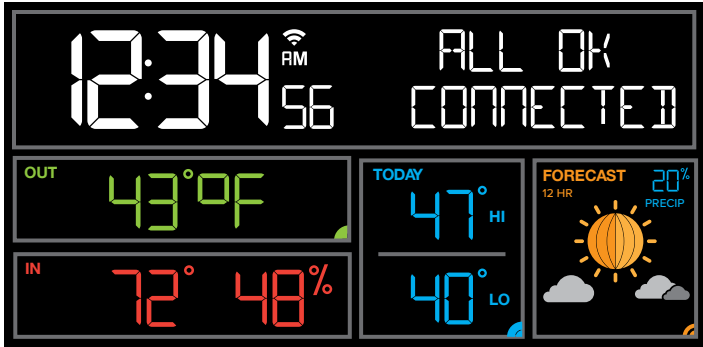

ALL OK CONNECTED

- Alarm clock is connected all the way through to the La Crosse View app.

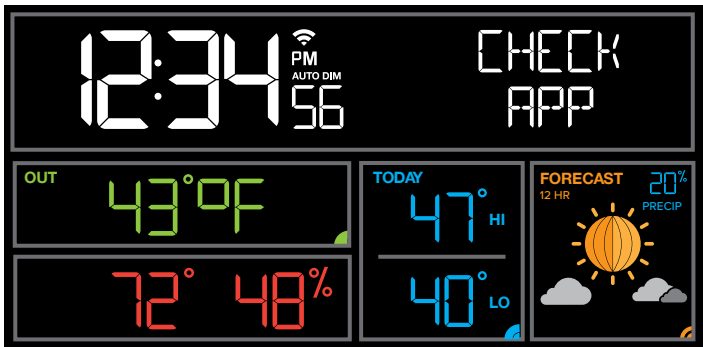

CHECK APP

- The Wi-Fi router connection is working.
- Check your connection to the La Crosse View app.
- Check Notifications in the La Crosse View app
- Is there an update to install?

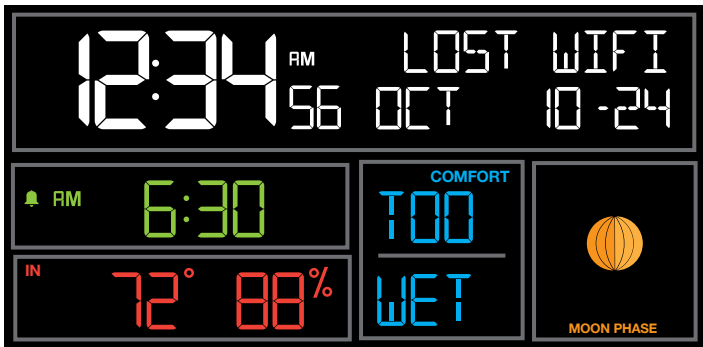

LOST WIFI

- Check your power cord connection (power cord required to connect)
- When trying to reestablish your alarm clock's Wi-Fi connection, be sure your mobile device is on the same 2.4GHz network you want your alarm clock to use.
- Check your network connection.
- Hold the + and – buttons together for 3 seconds to search for Wi-Fi.

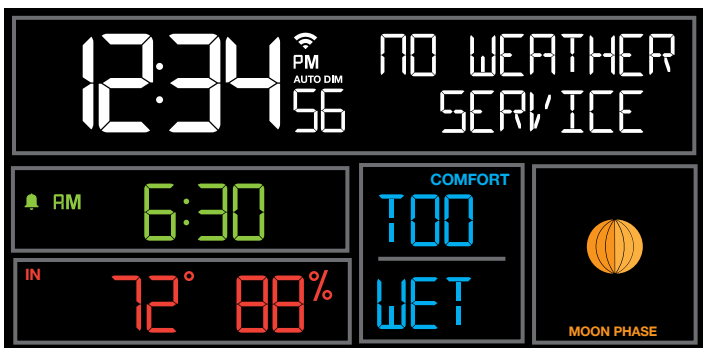

NO WEATHER SERVICE

- Wi-Fi, and App are fine.
- Weather/Time service not connecting. This will be resolved at the Weather Server. Please be patient.
- Weather Forecast, Precipitation and Weather HI/LO temperature will not be displayed.

FEATURES OF YOUR ALARM CLOCK

Your alarm clock provides most functionality when connected to the La Crosse View app. However it is fully functional as a **standalone projection alarm clock**.

Here we have included the details for various functions of your alarm clock:

- Adjustable Backlight
- Auto Dim Backlight
- Settings Menu
- Projection
- Time Alarm with Snooze
- Nap Feature
- Moon Phase
- Indoor Comfort
- USB Charging Port
- Low Battery Indicator
- Factory Restart Alarm clock

ADJUSTABLE BACKLIGHT

Your alarm clock has 5 levels of brightness for the backlight:

- Press and release the LIGHT button to adjust the backlight at 5 levels of intensity.
Levels: OFF = 0% | level 1 = 15% | level 2 = 20% | level 3 = 50% | level 4 = 100%.

AUTO DIMMING BACKLIGHT

You can set your backlight to automatically dim to level 1 at a set hour for sleeping, then automatically return to full brightness when you wake.

Set Auto Dim (Hour only):

1. Hold the SNOOZE/LIGHT button 2 seconds to enter dimmer set mode. AUTO DIM OFF will show.
2. Press the + or – buttons to turn dimmer (ON). AUTO DIM ON will show.
3. Press the SNOOZE/LIGHT button to select start time (Hour) for dimmer. AUTO DIM START TIME and the hour will flash.
4. Press the + or – buttons to change the hour for the dimmer to be low light level.
5. Press the SNOOZE/LIGHT button to select start time for dimmer to be on High light level. AUTO DIM STOP TIME and the hour will flash.
6. Press the + or – buttons to change the hour for the dimmer to be high light level.
7. Press the SNOOZE/LIGHT button to confirm exit.

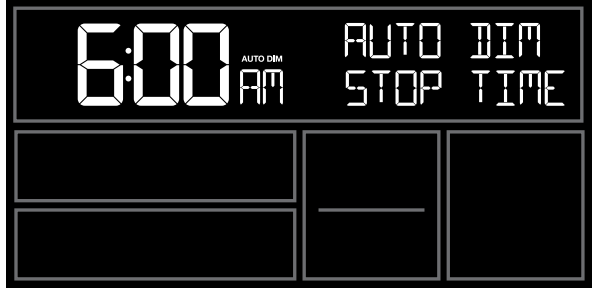
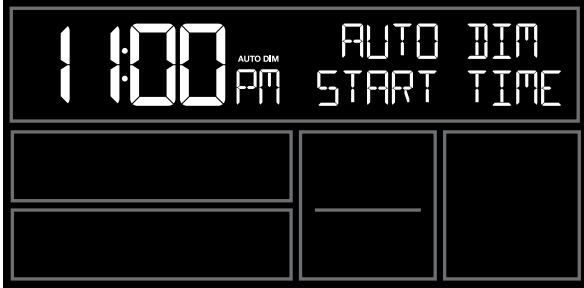
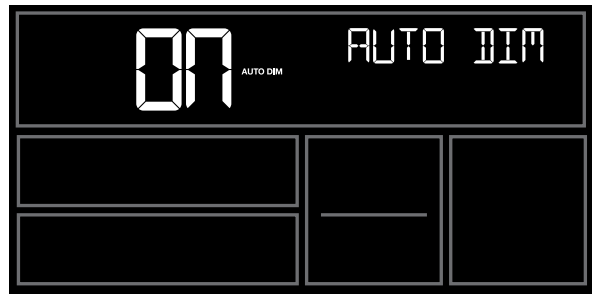
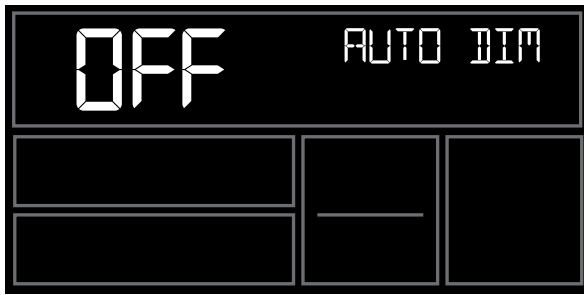

Note: If you press the LIGHT button to manually adjust the backlight, the Auto Dim feature will resume at the next scheduled time to dim.

SETTINGS MENU

1. Hold the SET button for 3 seconds to enter settings menu.
2. Press and release the + or - buttons to adjust the flashing values. Hold to adjust quickly.
3. Press and release the SET button to confirm and move to the next item.

Note: Press and release the SNOOZE/LIGHT button any time to exit settings.

Settings menu order:

- BEEP ON | OFF
- 12/24 hour format
- Hour
- Minutes
- Year
- Month
- Date
- Temperature Fahrenheit | Celsius

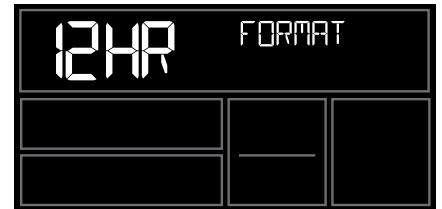

Note: Weekday sets automatically as Year, Month and Date are set.

PROJECTION

Your alarm clock has projection with intensity levels, rotation, focus and the ability to select what is to be projected.

INTENSITY: Press and release the  button to adjust the Projection Intensity (HI-MED-LO-OFF). Projection level will show briefly on the alarm clock.

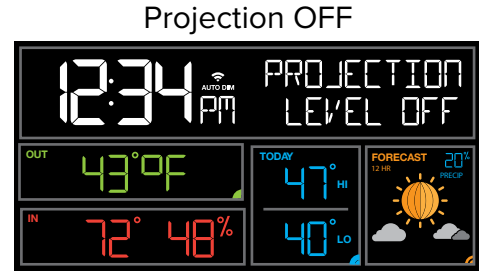
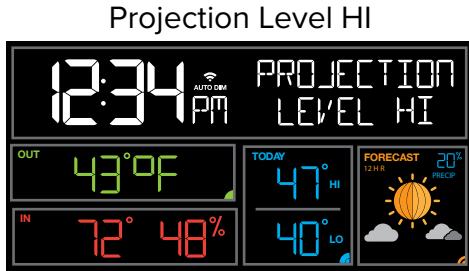

ROTATION: The projection tube on the back of your station allows you to rotate the projected image 270 degrees. Simply turn the bottom of the tube to adjust.

FOCUS: Turn the top wheel on the projection tube to focus the projected image.

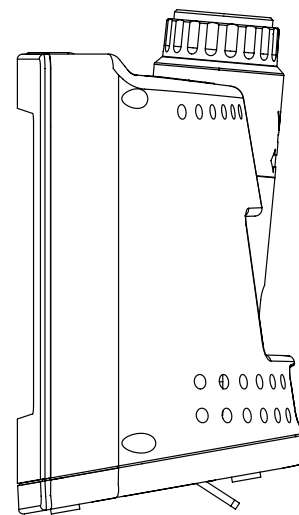
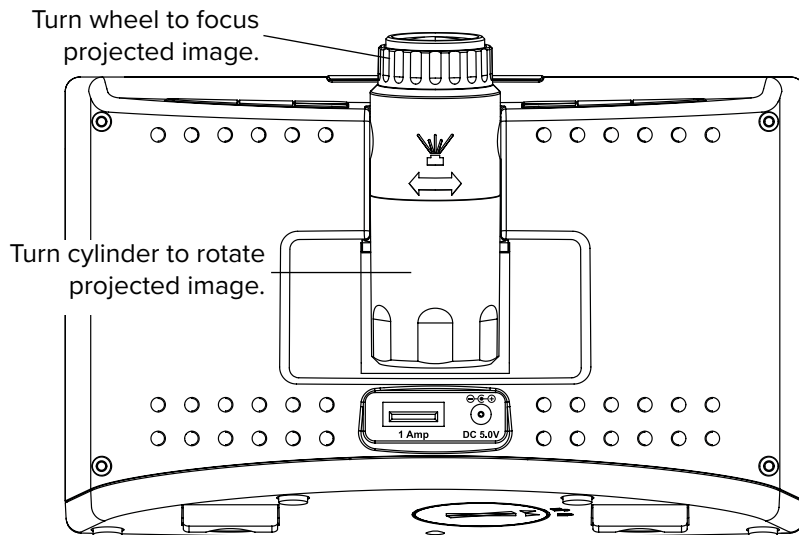

The Projection arm tips back and forth slightly to position image on ceiling.

SELECTION: Time is the default projection image. Press and release the PROJ INFO button to select a different item to project. Alarm clock will stay on last item selected.

Options:

- Current Time
- Indoor Temperature/Humidity
- Internet Outdoor Temperature (when connected)
- Extra Sensor Information (if Extra Sensor is connected to alarm clock)

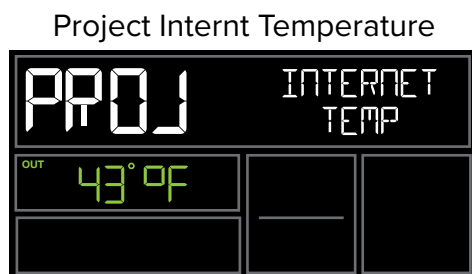

ALTERNATE SELECTION: You may choose to alternate the Time Projection with another item. Time and selected item will alternate every 5 seconds.

1. Hold PROJ INFO button 2 seconds to choose alternate projection mode. ALT WITH TIME OFF will show.
2. Press and release the + or – buttons to select ALT WITH TIME ON.
3. Press and release the PROJ INFO button to toggle through selections.
4. Press the SNOOZE LIGHT button to exit.

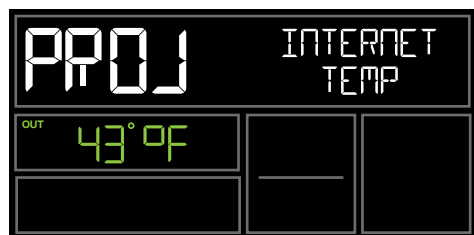

ALARM WITH CUSTOM SNOOZE TIME

Set Alarm Time:

1. Hold the ALARM button for 3 seconds to enter alarm time set mode. The alarm hour will flash. Press the + or - buttons to set alarm hour
2. Press the ALARM button to confirm and move to the minutes. The alarm minutes will flash. Press the + or - buttons to set the minutes.
3. Press the ALARM button to confirm and move to snooze duration. The snooze time will flash and start at the preset of 10 minutes. The date area will read “SNOOZE”
4. Press + or - buttons to set Snooze Duration. Increase or decrease in 5 min intervals up to 120 min.
5. Press and release the ALARM button to confirm and exit.

Note: Alarm is crescendo sound. When the alarm sounds, it continues for 2 minutes and then shuts off completely.

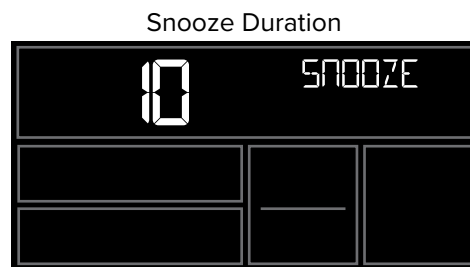
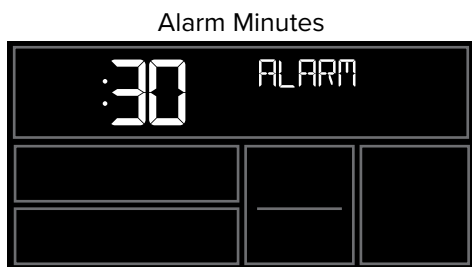
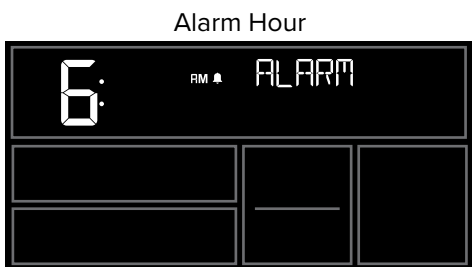

Alarm is active when set.
Can show in Extra Sensor area

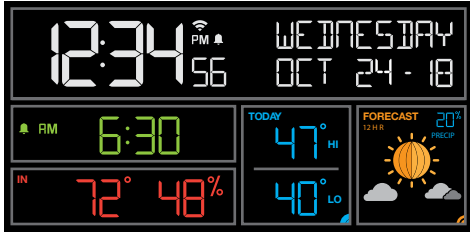

Alarm is active-bell icon shows be time.
Internet Temperature shown in Extra Sensor area

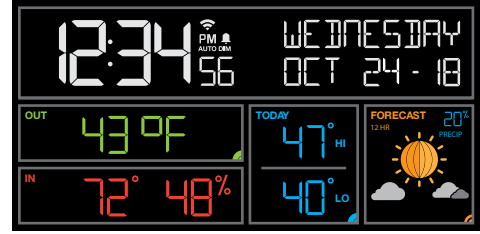

Deactivate Alarm:

1. From normal time display, press and release the ALARM button to activate or deactivate alarm.
2. Alarm time will show for 3 seconds (with or without bell icon) in Extra Sensor area. Everything else disappears on screen.
3. Alarm icon will show when active and disappear when deactivated.
 - Alarm icon will flash when alarm sounds.
 - When alarm sounds, press any button except for SNOOZE/LIGHT to stop ringing for one day

Alarm time shows briefly.



Alarm is inactive. No bell icon near time.

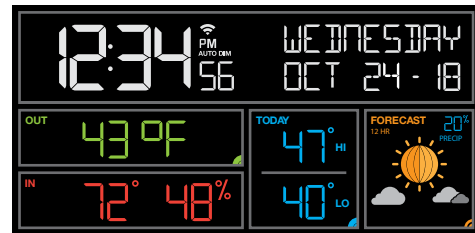

Snooze Time:

- When alarm sounds, press SNOOZE/LIGHT button to stop the alarm and activate SNOOZE function. SNOOZE - duration will show in date area. Alarm icon will flash.
- During snooze count down, press any button except for SNOOZE/LIGHT to exit snooze count down
- During snooze count down, press SNOOZE/LIGHT only to change backlight
- When snooze alarm sounds, SNOOZE – duration “0m 00” will flash. Station beeps for 2 minutes then returns to normal display or press any button to stop ringing and return to normal display. Press any button except for SNOOZE/LIGHT to stop alarm and exit snooze function.
- Repeat: When snooze alarm sounds, SNOOZE – duration “0m 00” will flash, for up to 2 minutes with alarm sounding. Press SNOOZE/LIGHT button to stop the sound and activate the snooze function again.

Snooze countdown

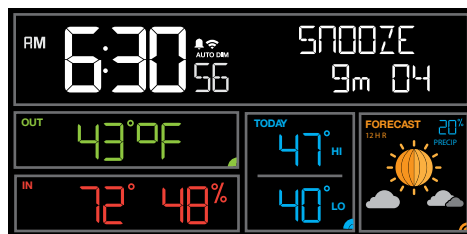

NAP TIMER

Sometimes it is easier to use the Nap Timer to avoid reprogramming your time alarm. Set it one time then just press the NAP button to start the timer.

Set Nap Timer:

1. Press and hold the NAP button for 3 seconds to enter nap set mode.
2. The time will flash and start at the preset of 30 minutes. The date area will read “NAP TIME”
3. Press + or - buttons to set nap duration. Increase or decrease in 5 min intervals up to 120 min.
4. Press the NAP button to confirm and start nap.
 - While a nap is in progress the date area will display “NAP TIME” and time will count down to zero when the alarm will sound.
 - The nap duration will be saved in the station. Next time the NAP button is pressed it will display the amount of time used last and the nap will start.
 - When alarm sounds, NAP TIME “0m 00” will flash. Alarm beeps for 2 minutes then returns to normal display or press any button to stop ringing and return to normal display.

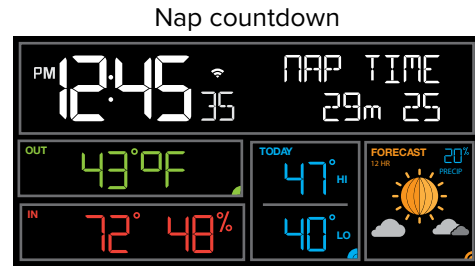

MOON PHASE

The Moon Phase will only show when if your alarm clock is not connected to the La Crosse View app. When your alarm clock is connected, the Moon Phase will be replaced by 12 hour Forecast Icons.

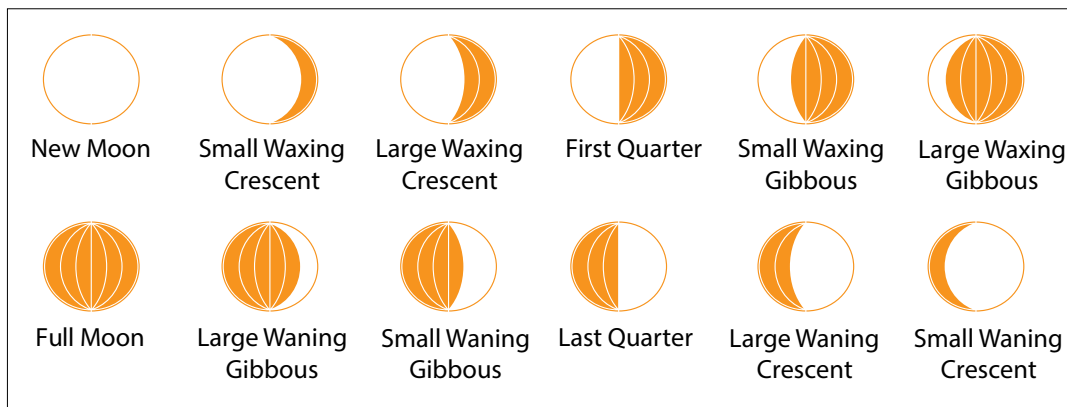

INDOOR COMFORT STATEMENT

- Indoor Comfort Statement is based on the Indoor Humidity reading.
- The Indoor Comfort Statement will only show when if your alarm clock is not connected to the La Crosse View app.
- When your alarm clock is connected, the Indoor Comfort Statement will be replaced by Forecast HI/LO Temperatures.

Not Connected: Indoor
Comfort from Alarm Clock



Indoor Comfort:

- TOO WET 84% to 99% RH
- IN WET 71% to 83% RH
- IN OK 40% to 70% RH
- IN DRY 26% to 39% RH
- TOO DRY 1% to 25% RH

USB CHARGING PORT

There is a 1 Amp USB charge port on the back of the station. Power Cord must be in use to charge a device.

- Connect your external device's USB charging cable (not included) to the USB charging port.
- Charging times will vary.
- USB Power Output: 1A maximum current. Charge 1A devices or devices that are self-regulating.

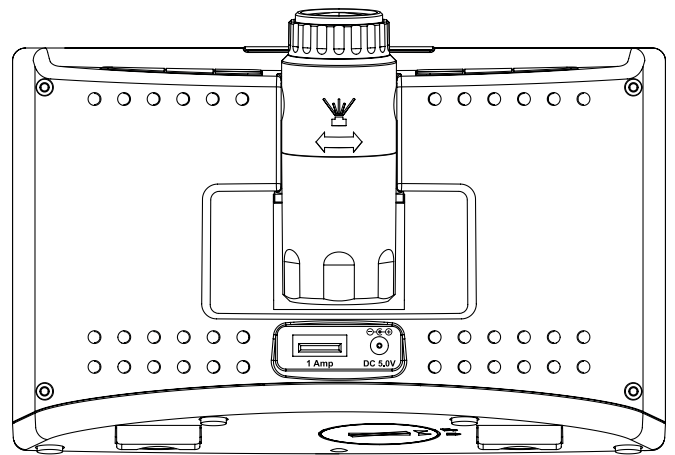
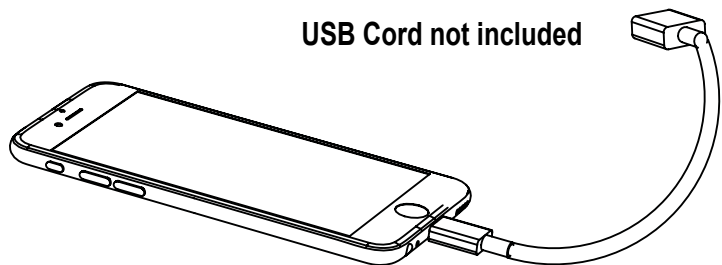

LOW BATTERY INDICATOR

- Low Battery by Indoor Temperature, replace battery in your Alarm clock.

FACTORY RESET ALARM CLOCK

A factory restart of your alarm clock will remove all Wi-Fi settings and returns your alarm clock to its default settings and “out of the box” condition. This may resolve connection issues with your sensors or Wi-Fi.

1. Hold the ALARM and NAP buttons together for 5 seconds.
2. Your alarm clock will reset and search for Wi-Fi.
3. If sensors are attached, the alarm clock will search for all sensors. Allow up to 3 minutes to acquire sensors.
4. You will need to reconnect to your La Crosse View app by following the steps on [page 7](#).

WE'RE HERE TO HELP!

If you require additional support, call our friendly customer support team based out of La Crosse, Wisconsin.
Phone: 1.844.200.8752

Or fill out our online support request form here: bit.ly/contact_techsupport

Our knowledgeable customer support team is available: Monday-Friday, 8am-6pm CST.

JOIN THE CONVERSATION

Ask questions, watch detailed setup videos, and provide feedback on our social media outlets!



CARE & MAINTENANCE

- Do not mix old and new batteries in extra sensors.
- Do not mix Alkaline, Standard, Lithium, or Rechargeable Batteries.
- Always purchase the correct size and grade of battery most suitable for intended use.
- Replace all batteries of a set at the same time.
- Clean the battery contacts and also those of the device prior to battery installation.
- Ensure the batteries are installed with correct polarity (+ and -).
- Remove batteries from equipment when it is not used for an extended period of time.
- Promptly remove expired batteries.

SPECIFICATIONS

Indoor

Temperature Range: 32°F to 99°F (0°C to 37°C)

Humidity Range 10% RH to 99%RH

Power

C82929 Alarm Clock: 5.0 Volt power cord included (Required)
AC6: HX12H-0501500-AU-001 (Input 100-240V)

Battery Backup: CR2032 battery included, backup for time and date

Battery Life

C82929 Alarm Clock: over 24 months with power cord use

Dimensions

C82929 Alarm clock: 6.04" W x 2.42" D x 4.10" H (15.34 cm x 6.15 cm x 10.41 cm)

WARRANTY & SUPPORT

La Crosse Technology, Ltd. provides a 1-year limited time warranty (from date of purchase) on this product relating to manufacturing defects in materials & workmanship.

Before returning a product, please contact our friendly customer support with questions or visit our online help:

Phone: 1-844-200-8752

Online Product Support and Registration: www.lacrossetechnology.com/support

⚠ WARNING: This product can expose you to chemicals including styrene, which is known in the State of California to cause cancer. For more information go to: www.P65Warnings.ca.gov/

FCC STATEMENT

This equipment has been tested and found to comply with the limits for a Class B digital device, pursuant to part 15 of the FCC Rules. These limits are designed to provide reasonable protection against harmful interference in a residential installation. This equipment generates, uses and can radiate radio frequency energy and, if not installed and used in accordance with the instructions, may cause harmful interference to radio communications. However, there is no guarantee that interference will not occur in a particular installation.

If this equipment does cause harmful interference to radio or television reception, which can be determined by turning the equipment off and on, the user is encouraged to try to correct the interference by one or more of the following measures:

- Reorient or relocate the receiving antenna.
- Increase the separation between the equipment and receiver.
- Connect the equipment into an outlet on a circuit different from that to which the receiver is connected.
- Consult the dealer or an experienced radio/TV technician for help.

This device must not be co-located or operating in conjunction with any other antenna or transmitter.

Operation is subject to the following two conditions:

- (1) This device may not cause harmful interference, and
- (2) This device must accept any interference received, including interference that may cause undesired operation.

Caution!

The manufacturer is not responsible for any radio or TV interference caused by unauthorized changes or modifications to this equipment. Such changes or modifications could void the user authority to operate the equipment.

This equipment must be installed and operated in accordance with provided instructions and the antenna(s) used for this transmitter must be installed to provide a separation distance of at least 20 cm from all persons and must not be co-located or operating in conjunction with any other antenna or transmitter

All rights reserved. This manual may not be reproduced in any form, even in part, or duplicated or processed using electronic, mechanical or chemical process without the written permission of the publisher. This booklet may contain errors or misprints.

The information it contains is regularly checked and corrections are included in subsequent editions. We disclaim any responsibility for any technical error or printing error, or their consequences.

All trademarks and patents are recognized.

CANADA STATEMENT

This device complies with Industry Canada's licence-exempt RSSs. Operation is subject to the following two conditions:

- (1) This device may not cause interference; and
- (2) This device must accept any interference, including interference that may cause undesired operation of the device.

Le présent appareil est conforme aux CNR d'Industrie Canada applicables aux appareils radio exempts de licence. L'exploitation est autorisée aux deux conditions suivantes :

- (1) l'appareil ne doit pas produire de brouillage;
- (2) l'utilisateur de l'appareil doit accepter tout brouillage radioélectrique subi, même si le brouillage est susceptible d'en compromettre le fonctionnement.

Apple and the Apple logo are trademarks of Apple Inc., registered in the U.S. and other countries.

App Store is a service mark of Apple Inc.

Google Play and the Google Play logo are trademarks of Google Inc.

Made in China - Printed in China