



# Acrylic Spa Owner's Manual



Customer Service | 800•787•6649

## READ AND FOLLOW ALL INSTRUCTIONS



Unit is IPX5 Compliant

*Congratulations on your purchase!*

Your new spa will bring you years of  
enjoyment and relaxation.

Please take the time to familiarize yourself with the safety precautions,  
operational procedures, routine water maintenance and cleaning  
so that your spa will provide a  
healthy environment for all your bathers.

*Enjoy!*

## Contents

Important Safety Instructions and Warnings . . . . .	4
Prepare for Your New Spa	
Plan the Best Location . . . . .	6
Identifying the Spa's Electrical Components . . . . .	7
Electrical Installation (120 V 60HZ North America). . . . .	8
120v to 240v Conversion (Plug & Play Models Only) . . . . .	9
Electrical Installation (240 V 60HZ North America). . . . .	11
GFCI Wiring Diagram (240 V 60HZ North America). . . . .	12
GFCI Wiring Diagram (230 V 50HZ Europe) . . . . .	13
Operating Your Spa	
Filling and Starting Up Your Spa . . . . .	14
Priming the Pump . . . . .	15
Topside Control Panels. . . . .	16
Operational and Energy Tips. . . . .	19
Personal Settings (Jets, Air Controls, Diverters, Waterfalls) . . . . .	20
Maintaining Spa Water Quality	
Testing and Adjusting Spa Water . . . . .	21
Chemical Balance, Ozonator, Sanitation, Filtration . . . . .	21
Filter Cleaning . . . . .	23
Maintenance Schedule . . . . .	23
Vacation Care . . . . .	24
Chemical Safety . . . . .	24
Cleaning and Care	
Draining Your Spa . . . . .	25
Cleaning Your Spa . . . . .	25
Removing and Reseating the Pillows . . . . .	25
Spa Cover . . . . .	26
Sound System . . . . .	26
Winterizing . . . . .	27
Troubleshooting	
Water Quality Problems. . . . .	29
Operational Problems. . . . .	30
Control Pack Codes . . . . .	39
Product Registration. . . . .	43

### CONTACT INFORMATION

For customer service, please call 1-800-787-6649

Strong™ Industries  
3204 Point Township Drive, Northumberland, PA 17857 USA

*The manufacturer reserves the right to make product modifications and enhancements without notice.  
Specifications and dimensions are approximate and for reference only.*

## Important Safety Instructions and Warnings

# READ AND FOLLOW ALL INSTRUCTIONS

**To reduce the risk of injury, do not permit children to use this product unless they are closely supervised at all times.**



**Warning:** Children should not use spas or hot tubs without adult supervision.

**Avertissement:** Ne pas laisser les enfants utiliser une cuve de relaxation sans surveillance.



**Warning:** Do not use spas or hot tubs unless all suction guards are installed to prevent body and hair entrapment.

**Avertissement:** Pour éviter que les cheveux ou une partie du corps puissent être aspirés, ne pas utiliser une cuve de relaxation si les grilles de prise d'aspiration ne sont pas poutes en place.



**Warning:** People using medications and/or having an adverse medical history should consult a physician before using spa or hot tub.

**Avertissement:** Les personnes qui prennent des médicaments ou ont des problèmes de santé devraient consulter un médecin avant d'utiliser une cuve de relaxation.



**Warning:** People with infectious diseases should not use a spa or hot tub.

**Avertissement:** les personnes atteintes de maladies infectieuses ne devraient pas utiliser une cuve de relaxation.



**Warning:** To avoid injury, exercise care when entering or exiting the spa or hot tub.

**Avertissement:** Pour éviter des blessures, user de prudence en entrant dans une cuve de relaxation en sortant.



**Warning:** Do not use drugs or alcohol before or during the use of a spa or hot tub, to avoid unconsciousness and possible drowning.

**Avertissement:** Pour éviter l'évanouissement et la noyade éventuelle, ne prendre ni drogue ni alcool avant d'utiliser une cuve de relaxation ni quand on s'y trouve.



**Warning:** Pregnant or possibly pregnant women should consult a physician before using a spa or hot tub.

**Avertissement:** Les femmes enceintes, que leur grossesse soit confirmée ou non, devraient consulter un médecin avant d'utiliser une.



**Warning:** Water temperature in excess of 38°C may be injurious to your health.

**Avertissement:** Il peut être dangereux pour la santé de se plonger dans de l'eau à plus de 38°C.



**Warning:** Before entering the spa or hot tub, measure the water temperature with an accurate thermometer.

**Avertissement:** Avant d'utiliser une cuve de relaxation mesurer la température de l'eau à l'aide d'un thermomètre précis.



**Warning:** Do not use a spa or hot tub immediately following strenuous exercise.

**Avertissement:** Ne pas utiliser une cuve de relaxation immédiatement après un exercice fatigant.

## SAVE THESE INSTRUCTIONS

# READ AND FOLLOW ALL INSTRUCTIONS

**To reduce the risk of injury, do not permit children to use this product unless they are closely supervised at all times.**



**Warning:** Prolonged immersion in a spa or hot tub may be injurious to your health.

**Avertissement:** L'utilisation prolongée d'une cuve de relaxation peut être dangereuse pour la santé.



**Warning:** Do not permit or use electric appliances (such as a light, telephone, radio or television) within 1.5 meters of spa or hot tub.

**Avertissement:** Ne pas placer d'appareil électrique (luminaire, téléphone, radio, téléviseur, etc.) à moins de 1.5 meters de cette cuve de relaxation.



**Caution:** Maintain water chemistry in accordance with the manufacturer's instructions.

**Attention:** La teneur de l'eau en matières dissoutes doit être conforme aux directives du fabricant.



**Caution:** In order to avoid a hazard due to inadvertent resetting of the thermal cut-out, this appliance must not be supplied through an external switching device, such as a timer, or connected to a circuit that is regularly switched on and off by the utility.



## **HYPERTHERMIA**

Hyperthermia occurs when the internal temperature of the body reaches a level several degrees above the normal body temperature of 37°C. The symptoms of hyperthermia include:

- 1) Unawareness of impending hazard;
- 2) Failure to perceive heat;
- 3) Failure to recognize the need to exit the spa or hot tub;
- 4) Physical inability to exit the spa or hot tub;
- 5) Fetal damage in pregnant women; and
- 6) Unconsciousness and resulting in the danger of drowning.



**Warning:** The use of alcohol or drugs can greatly increase the risk of fatal hyperthermia in hot tubs or spas.

**Avertissement:** La consommation d'alcool ou de drogue augmente considérablement.



**Warning:** The appliance is not to be used by persons (including children) with reduced physical, sensory or mental capabilities, or lack of experience and knowledge, unless they have been given supervision or instruction.

# SAVE THESE INSTRUCTIONS

## Prepare for Your New Spa

### Prepare for Your New Spa

Most cities and counties require permits for exterior construction and electrical circuits. In addition, some communities have codes requiring residential barriers such as fencing and/or self-closing gates on property to prevent unsupervised access to the property by children. See codes, page 7. Your local code enforcement officer can provide information on which permits may be required and how to obtain them prior to the delivery of your spa.

### Prepare a Good Foundation

**Damage caused by an inadequate or improper foundation is not covered by the warranty. The spa owner is responsible for providing a proper foundation.** Place the spa on a solid, level foundation. If you are installing the spa indoors (not recommended), pay close attention to the flooring beneath it. Choose flooring that will not be damaged or stained. If you are installing your spa on an elevated wood deck or other structure, consult a structural engineer or a contractor to ensure the structure will support the weight of 150 pounds per square foot. An adequate drainage system has to be provided to deal with overflow water.



### Plan the Best Location

#### SAFETY FIRST

Do not place your spa within 10 feet (3 m) of overhead power lines.

### Consider Spa Use

How you intend to use your spa will help you determine where you should position it. For example, will you use your spa for recreational or therapeutic purposes? If your spa is mainly used for family recreation, be sure to leave plenty of room around it for activity. If you will use it for relaxation and therapy, you will probably want to create a specific mood around it.

### Climate, Privacy and View

Place the spa near a house entry if you live in a snowy or rainy environment so you have a place to comfortably change clothes. Consider seasonal changes, too. Bare trees don't provide much privacy. And don't forget to think of your neighbors' view of you, and your view of your neighbors.

### Keep Your Spa Clean

In planning your spa's location, consider a location where there is a clean path to and from the house. Use a mat at the spa's entrance to encourage bathers to clean their feet before entering your spa.

### Allow for Service Access

If you are installing your spa near a wall or with any type of structure on the outside, such as a gazebo, remember to allow a minimum of 18" access for service.



# Identifying the Spa's Electrical Components

**Locate Electrical Pack Part Number and Model Number** on the metal plate mounted on outside of spa panel.



Spa Model No.	Usage Description and Settings	Suggested GFCI Size*	Wire(s) Required
<b>Model No.</b> 6-0000, 6-0001	<b>1 pump spa plug and play</b>	<b>120V 15 AMP</b>	<b>#14 AWG Outlet</b>
<b>Model No.</b> 6-0000, 6-0001, 6-1000, 6-1001, 6-1002, 6-1010, 6-1011, 6-1012, 6-1100, 6-1101, 6-1102, 6-1110, 6-1111, 6-1112	<b>1 pump spa or 1-pump spa + blower (Pump on hi + heat)</b>	<b>240V 40 AMP</b>	<b>#6 AWG Copper</b>
<b>Model No.</b> 6-2001, 6-2002, 6-2011, 6-2012, 6-2101, 6-2102, 6-2111, 6-2112,	<b>2 pump (one 2-speed &amp; one 1-speed) (Pump on hi + heat) or 2 pump spa + blower</b>	<b>240V 50 AMP</b>	<b>#6 AWG Copper</b>
<b>Model No.</b> 6-3001, 6-3002, 6-3011, 6-3012, 6-3101, 6-3102, 6-3111, 6-3112, 6-4001, 6-4002, 6-4011, 6-4012, 6-4101, 6-4102, 6-4111, 6-4112	<b>3 pump spa or 3 pump spa + blower or 4 pumps</b>	<b>240V 60 AMP</b>	<b>#6 AWG Copper</b>
<b>Model No. GS500 (L1, N1)</b> 5-100, 5-1000 5-101, 5-1001	<b>1 pump European Spa</b>	<b>230V 13 AMP</b>	<b>#6 AWG Copper</b>
<b>Model No. GS500 (L1, N1, L2, N2)</b> 5-100, 5-1000, 5-1010, 5-1100, 5-1110 5-101, 5-1001, 5-1011, 5-1101, 5-1111	<b>1 pump European Spa</b>	<b>230V 40 AMP</b>	<b>#6 AWG Copper</b>
<b>Model No. GS520SZ (L1, N1, L2, N2)</b> 5-2001, 5-2003, 5-2011, 5-2013, 5-2101, 5-2103, 5-2111, 5-2113 5-3001, 5-3003, 5-3011, 5-3013, 5-3101, 5-3103, 5-3111, 5-3113	<b>2 pump European Spa</b>	<b>230V 40 AMP</b>	<b>#6 AWG Copper</b>

**Certifications:**

Spas, US:  
ETL #101138129TOR-001B  
Spas, Europe:  
CE #3180220  
Spa Covers:  
ASTM #F1346

\*Note: GFCI is required. Suggested size will ensure proper operation. Exact Rating will appear on unit's metal ID Tag.

## Prepare for Your New Spa

# I 20 Volt Electrical Installation (Plug & Play models only) (North America 60hZ)

**Always follow applicable local, state and federal codes and guidelines.**

- On existing dedicated\* electrical service, a 15A breaker will work with no other appliances/accessories on that line.
- On new electrical service, usage of a 20A breaker on a dedicated\* line is recommended with no other appliances/accessories on that line.
- Cord-and-plug connections may not use a cord longer than 15 feet (4.6 m) and must be plugged into a dedicated 15A GFCI connection (NEC 680.42(A))



**DO NOT USE A GFCI OUTLET with a GFCI CORD!**



- Do not use extension cords!
- Always use a weatherproof-covered receptacle.
- Receptacle shall be located not less than 5 feet (1.5 m) from and not exceeding 10 feet (3.0 m) from the inside wall of the spa. (NEC 680.43(A))
- Do not bury the power cord. If your cord becomes damaged, replace it before next usage.
- All 120V spas come with a GFCI cord installed.
- Test the GFCI plug prior to first use and periodically when the spa is powered. To test the GFCI plug version, follow these instructions. (Spa should already be plugged in and operational.)

1. Press the TEST button on the GFCI. The GFCI will trip and the spa will stop operating.
2. Press the RESET button on the GFCI. The GFCI will reset and the spa will turn back on.

The spa is now safe to use.

- If the GFCI trips while the spa is in use, press the RESET button. If the GFCI does not reset, unplug the spa and call your local spa dealer for service. **DO NOT USE THE SPA!**

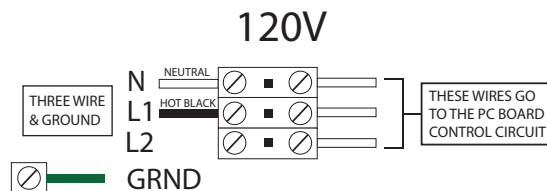
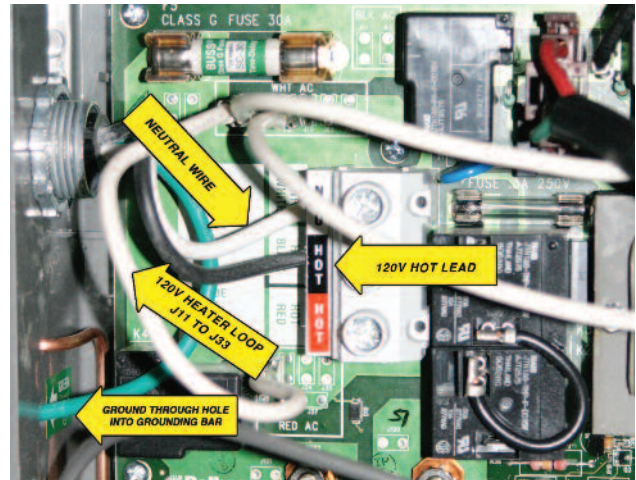

**\*IF A GFCI OUTLET IS PRESENT, EITHER THE GFCI CORD OR OUTLET WILL NEED TO BE REPLACED. CHECK WITH LOCAL CODE OFFICIALS ON OUTDOOR OUTLET REQUIREMENTS. IF GFCI OUTLET IS REQUIRED, CORD GFCI MUST BE REMOVED AND A NON-GFCI CORD USED. ONLY ONE INLINE GFCI CAN BE USED IN THE SPA CIRCUIT.**

**\*IF USING THE STANDARD 120V SERVICE, YOU MUST USE A DEDICATED LINE, WHICH MEANS THAT THERE CANNOT BE ANY OTHER HOUSEHOLD ITEMS CONNECTED TO THE CIRCUIT OR OUTLET AT ALL! HAVING ANY OTHER ELECTRICAL APPLIANCES AT ALL ON THIS CIRCUIT WHILE THE SPA IS RUNNING WILL TRIP THE BREAKER IMMEDIATELY. DO NOT USE ANY TYPE OF EXTENSION CORDS BETWEEN THE SPA AND THE WALL OUTLET, THIS WILL ALSO CAUSE THE BREAKER TO TRIP AND CAN BE A POTENTIAL FIRE HAZARD.**



# 120V to 240 V Conversion (Plug & Play Models only)

## (North America 60hZ)

Some spa owners choose to have their spa converted from 120V operation to 240V operation for greater energy efficiency.

 **WARNING:** The electrical circuit must be installed by a licensed electrical contractor and approved by a local building or electrical inspector. Customer must provide a disconnect in the fixed wiring.

Failure to comply with state and local codes may result in fire or personal injury and will be the sole responsibility of the spa owner.

## Prepare for Your New Spa

The steps to converting your spa from 120V to 240V operation are shown below and must be completed by a licensed electrician.

Power supply installation must include a properly rated GFCI circuit breaker. The circuit must be dedicated and should not be shared with any other appliances. It should be labeled and easily accessible to users. The power supply must be hard wired into the power pack. A hole may be drilled through the spa cabinet near the electrical pack to accommodate wiring. Foam insulation may be sprayed around the hole to fill any gaps between the cabinet and the wiring.

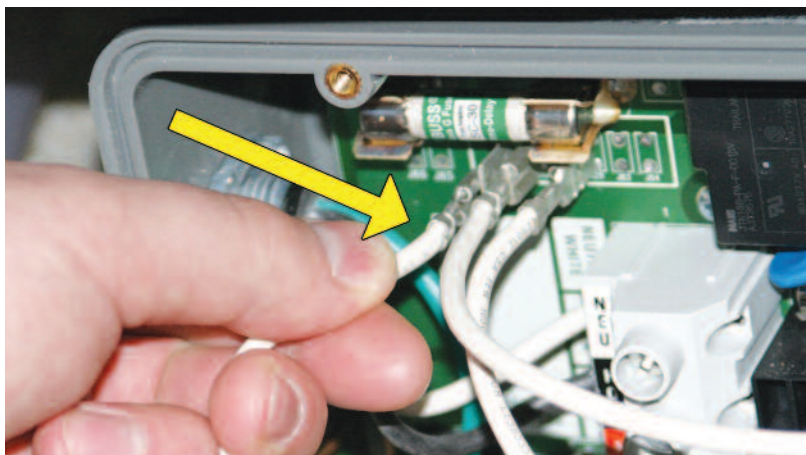

**Step 1.**  
Remove power from the spa

**Step 2.**  
Disconnect jumper from WHT AC.

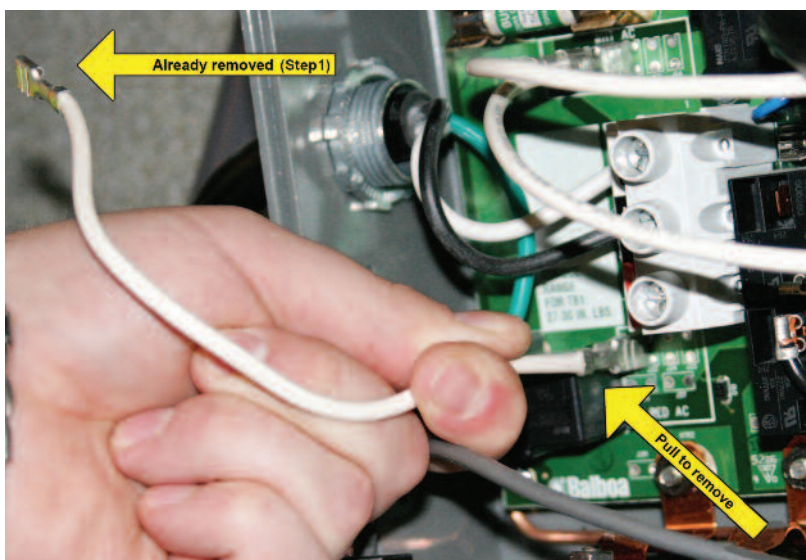

**Step 3.**  
Disconnect other end of same jumper from RED AC.

**DO NOT DISCONNECT ANY OTHER JUMPERS!**

**Note:** All connectors in WHT AC are interchangeable and the same is true of all connections in RED AC.

## Prepare for Your New Spa

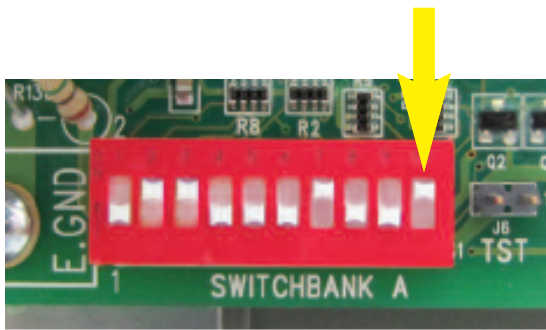

**Step 4.**  
**Turn Dip switch #10 off (down).**

All other Dip switches should remain the same unless mode change is to be enabled.

### Mode change VS501Z

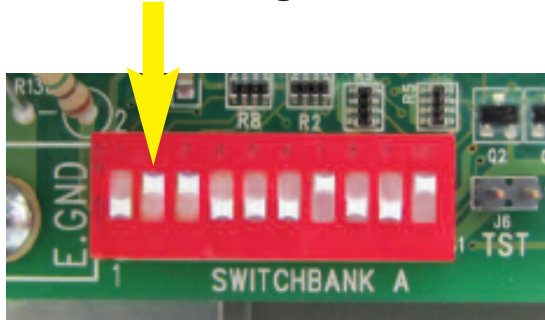

**Step 5. (optional)**  
**Enable mode change.**

A plug and play spa comes from the factory locked in standard mode so that the mode cannot be changed. To enable mode change, a dip switch must be turned to the off (down) position. Depending on the model of spa pack within the spa, the specific dip switch that would need to be changed will vary. If you have a VS501z spa pack, you will turn dip switch 2 off (down). If you have a VS300 spa pack you will turn dip switch 7 off (down).

### Mode change VS300FL4

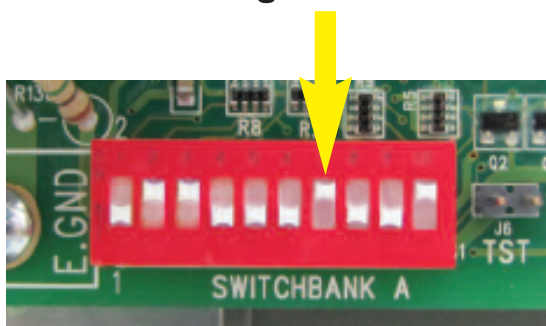

**Step 6.**  
**Remove 120 volt GFCI cord.**

A plug and play spa comes from the factory with 120 volt GFCI cord installed. To hook the spa up to 240 volts, the 120 volt GFCI cord must first be removed.

**Step 7.**  
**After all other steps have been completed, follow all instructions for a 240 volt install.**

**PLEASE CHECK YOUR LOCAL BUILDING CODES AND ONLY USE A CERTIFIED ELECTRICIAN TO INSTALL ANY ELECTRICAL COMPONENTS TO YOUR SPA.**

# 240 Volt Electrical Installation

(North America 60Hz)



**WARNING:**

*The electrical circuit must be installed by an electrical contractor and approved by a local building or electrical inspector. Customer must provide a disconnect in the fixed wiring.*

*Failure to comply with state and local codes may result in fire or personal injury and will be the sole responsibility of the spa owner.*

*Improper installations present hazards which can result in personal injury or property damage and void the warranty on the spa.*

Spa jumpers and dip switches are preconfigured for a 240V installation.

- All 240V spas must be permanently hardwired to the power supply. See US wiring diagram on page 9, European wiring diagram on page 10.
- Spas must be wired using this procedure. Any variance from these instructions will void your warranty and may result in serious injury.
- When installed in the United States, the electrical wiring of this spa must meet the requirements of National Electric Code, ANSI/NFPA 70-2008 and any applicable local, state, and federal codes.

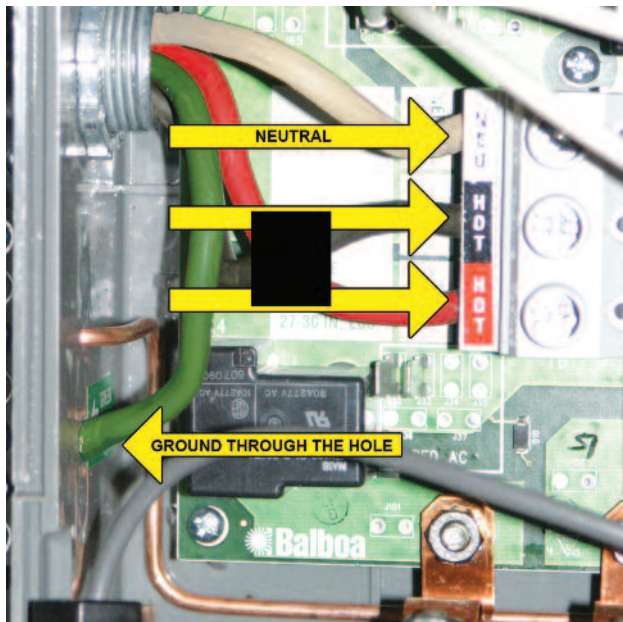

## GFCI and Wiring Requirements

- The power supplied to the spa must be on a dedicated GFCI protected circuit as required by ANSI/NFPA 70 with no other appliances or lights sharing the power.
- Use copper wire with THHN insulation. **Do not use aluminum wire.**
- When NEC requires the use of wires larger than #6 AWG, install a junction box near the spa and use #6 AWG wire between the junction box and the spa.
- Wire runs over 85 feet must increase wire gauge to the next lower number.
- Means for disconnection must be incorporated in the fixed wiring in accordance with the wiring rules.

## Testing the GFCI Breaker

Test the GFCI breaker prior to first use and periodically when the spa is powered. To test the GFCI breaker follow these instructions

1. With spa operating, press the TEST button on the GFCI. The GFCI will trip and the spa will shut off.
2. Reset the GFCI breaker by switching the breaker to the full OFF position, wait a moment, then turn the breaker back on. The spa should have power again.

## Point of Entry for Electric Service

Installations can vary greatly from spa to spa, therefore the manufacturer does not have any pre-determined entry points for electrical service. The installer will need to determine the best point of entry, and create an entry point. Any of the 4 walls or the spa base can be drilled through to make this access point. Prior to drilling, be sure that there are no components on the interior of the cabinet that will possibly be damaged or in the way while making the hole. The manufacturer recommends that some form of moisture barrier is used at the hole to prevent water from entering the spa. As long as all the above criteria are met, this will in no way void the warranty that is included with the spa.

# GFCI Wiring Diagram (North America 240V 60hZ)



**WARNING:**

The electrical circuit must be installed by an electrical contractor and approved by a local building or electrical inspector. Failure to comply with state and local codes may result in fire or personal injury and will be the sole responsibility of the spa owner. Customer must provide a disconnect in the fixed wiring.

Improper installations present hazards which can result in personal injury or property damage and void the warranty on the spa.

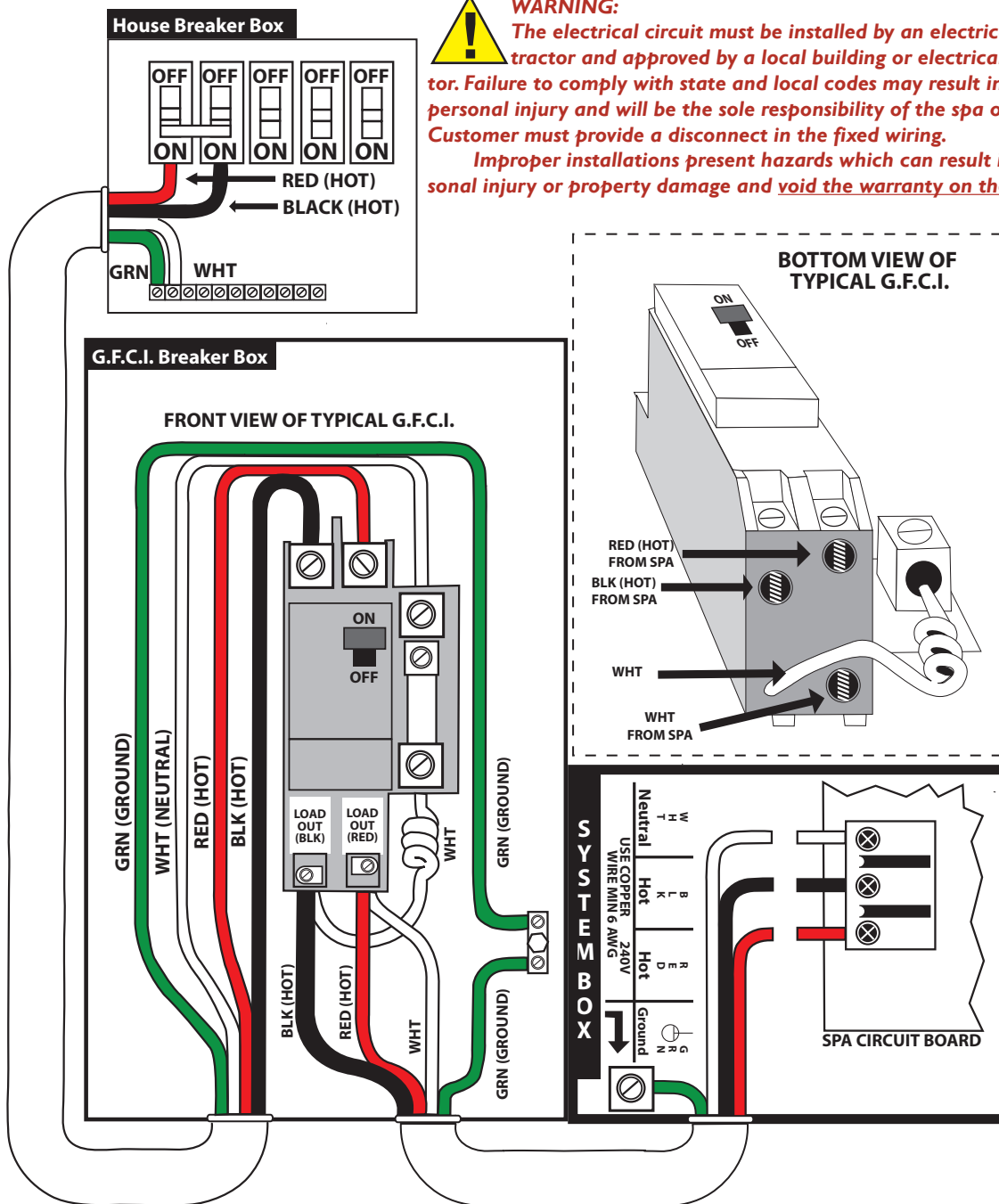

**IF THE NEUTRAL WIRE FROM THE SPA IS NOT CONNECTED DIRECTLY INTO THE LOAD NEUTRAL LUG ON THE GFCI BREAKER, THE BREAKER WILL TRIP CONSTANTLY. IF YOUR GFCI BREAKER DOES NOT HAVE A LOAD NEUTRAL LUG AND PIGTAIL WIRE, IT CANNOT BE USED WITH THE SPA.**

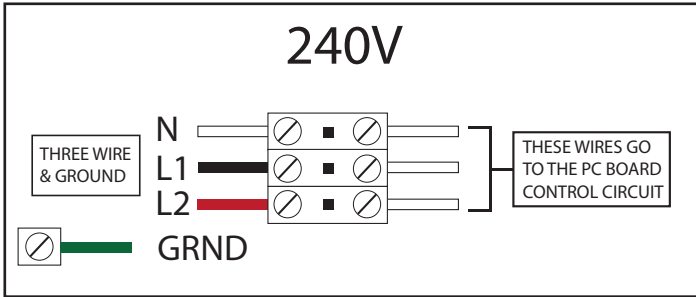

# GFCI Wiring Diagram (European 230V 50hZ) Systems with PCB Rev B Only

**For Certified Electrical Personnel reference ONLY!**

**Note: A residual current device with a tripping current rated not more than 30 mA has to be installed in addition to local requirement. Customer must provide a disconnect in the fixed wiring. Protective device for power connection must be on all phase conductors based on local requirements.**

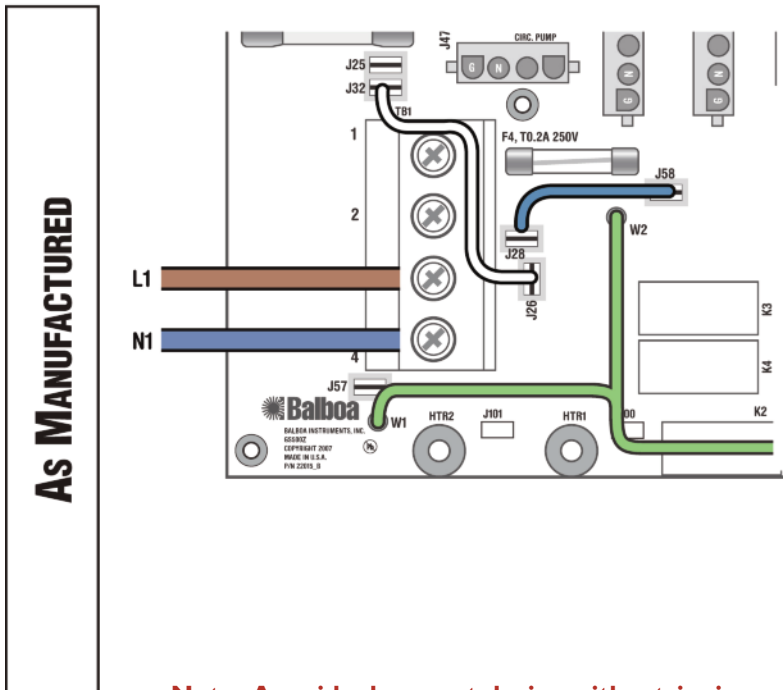

**Single Service, TN and TT Electrical Systems  
3 Wires (1 Line + 1 Neutral + 1 Protective Earth)  
Protective Earth wire 6mm<sup>2</sup> minimum  
(Green/Yellow) must be connected to system ground  
terminal as marked.**

This option is configured and shipped as the default.

All equipment (pumps, blower, and heater) runs on service line L1.

Systems using only 1 DIP switch (A10) for heat disable:

- For 1 x 16 Amp Service:  
DIP Switch A10 must be ON.
- For 1 x 32 Amp Service:  
Set DIP Switch A10 such that total system amperage draw never exceeds rated service input.

Systems using multiple DIP switches for heat disable:

- Refer to Switchbank settings on inside cover of pack.

**Note: A residual current device with a tripping current rated not more than 30 mA has to be installed in addition to local requirement. Customer must provide a disconnect in the fixed wiring. Protective device for power connection must be on all phase conductors based on local requirements.**

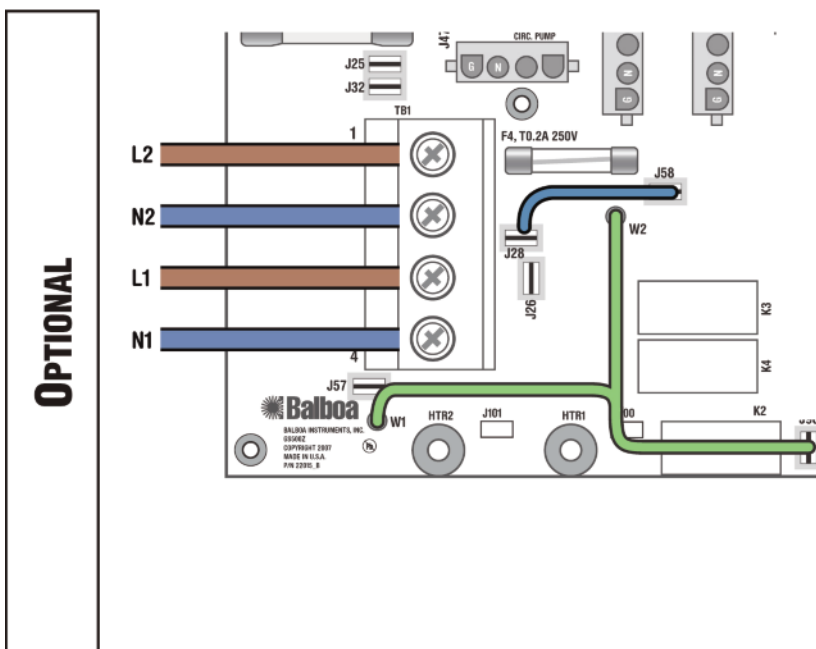

**Dual Service, TN and TT Electrical Systems  
5 Wires (2 Lines + 2 Neutrals + 1 Protective Earth)**

**Protective Earth wire 6mm<sup>2</sup> minimum  
(Green/Yellow) must be connected to system ground  
terminal as marked.**

The heater runs on service line L1, while all other equipment, such as pumps and blowers, run on service line L2.

Completely remove the white wire from J26 and J32.  
Note: J32 and J25 are electrically identical. The white wire may be attached to either terminal before removal.

Systems using only 1 DIP switch (A10) for heat disable:  
• DIP Switch A10 must be OFF.

Systems using multiple DIP switches for heat disable:  
• Refer to Switchbank settings on inside cover of pack.

## Operate Your Spa

# Filling and Starting

1. Place spa on an approved surface and have it properly wired by a licensed electrician.
2. Before filling spa test spa's electrical. Do not allow electrical to remain on longer than 30 seconds. If PR is displayed, turn off spa and fill. Locate drain hose before filling.
3. Remove exterior spa panel near Service Access side



4. Make sure plumbing unions are secure and did not loosen during shipping. There will be 4 unions on a 1-pump spa; 6 unions on a 2-pump spa; and 8 unions on a 3-pump spa. Hand-tighten any loose unions.

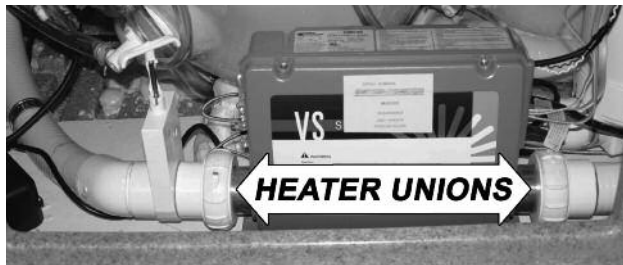
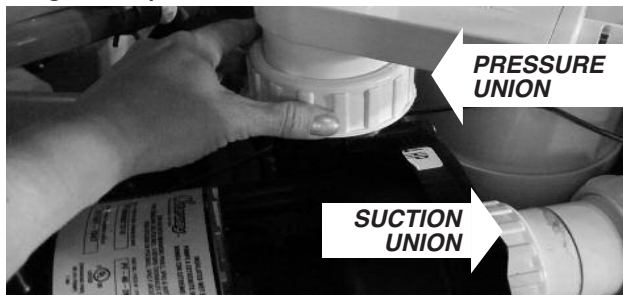

5. Verify all gate valves in the equipment area are open. Before operation, these valves must be in the UP/ OPEN position and have plastic clips inserted. Never run the spa with the gate valves closed or without water circulating for any period of time.



6. Remove the filter(s) (weir and basket also, if equipped) from filter chamber. Photos may vary from your particular spa model.

7. All of our spas are winterized using a biodegradable antifreeze in case a spa were to sit idle in cold weather prior to initial use. Use a garden hose to rinse your spa with regular tap water. The hose should be placed over jets and filter canister to push out any remaining antifreeze from the lines. Fill the foot well completely and drain using the guidelines stated in the "Draining Your Spa" section. Repeat this step if water draining out does not appear to be clear.

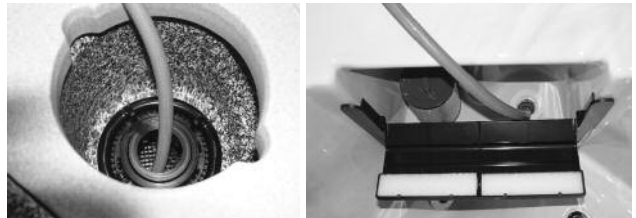

8. Place a garden hose in the filter chamber and fill your spa with regular tap water to 2" higher than the highest jet (excluding neck / shoulder jets). If the water is too high, it will overflow when people enter the bathing area. If the water is too low, air will enter through the filter and possibly cause airlock or even damage to the unit over time.

9. Install the filter(s) (weir and basket, if equipped) into the filter chamber.
10. Once the water is at the correct level, turn on the power at the GFCI breaker.  
*Note: When the power is turned on, the controls will perform a diagnostic check for a few minutes. When complete, the spa will automatically operate at filter speed and continue heating until water reaches 100°F.*
11. If water does not flow from jets when the pump is running, there could be an air pocket. See *Priming the Pump*, for methods of removing air pockets from the pump(s).

## Priming the Pump

Sometimes air can become trapped in the pump while filling the spa. You will know this has happened when after you have filled and started the spa, the pump does not function. You will hear the pump operating, but no or little water will be moving. **The pump will not work properly while air is trapped in it. Con-tinuing to operate the pump in this way will cause damage.**

New spa owners often have difficulty the first time they start their spa and the pump fails to prime. This can be frustrating, but these simple instructions can help you.

### **To remove small air bubbles trapped in the pump.**

1. Turn the spa on and wait for **PR** (Priming Mode) to appear on the topside display.
2. Press the JETSI button to turn on the pump and let it run for 10 seconds. The pump should be running on low speed.
3. Press the JETSI buttons again and let the pump run on high speed for 10 seconds.
4. Press the JETSI button again to turn off the pump. The pump should be left in the off position for 10 to 15 seconds.
5. Repeat steps 1 through 4 until water is flowing through all the jets and all air is removed from the plumbing.



### **To remove a large air lock within the pump:**

1. Turn off power at the breaker.
2. Remove the spa panel closest to the pump.
3. Loosen the Pressure Union on top of the pump by hand or with a strap wrench. You may hear a hissing sound or see bubbles. Eventually you will be left with a solid stream of water. When air is bled out, tighten the union, turn breaker on and set the pump on high speed.



## Operate Your Spa

# Topside Control Panels

## System Settings

When your spa is first actuated, it will go into Priming mode, indicated by "Pr." The Priming mode will last for less than 5 minutes (press a Temperature button to skip Priming Mode) and then the spa will begin to take temperature readings, followed by the heater test cycle. After completed, the heater will turn on, heat the spa and maintain the water temperature in the Standard mode.

The start-up temperature is set at 100°F/37°C. The last measured temperature is constantly displayed on the LCD. Note that the last measured spa temperature displayed is current only when the pump has been running for at least 2 minutes.

**Maximum Temperature is set at 104°F/40°C as required by UL/CSA.**

**Minimum temperature is 80°F/26°C.**

*Note: If the spa is currently in a heating or filtration cycle the primary pump will only switch between high and low. It cannot be turned off until the heating or filtration cycle is completed.*

## Preset Filter Cycles

**F1 F2**

The first filter cycle begins 6 minutes after the spa is energized.

The second filter cycle begins 12 hours later. The default filter time is 2 hours. Recommended setting is F2.

*Example: In a 12 hour period (1 cycle), a setting of F2 means 2 hours of filtration on, 10 hours of filtration off.*

*You may choose F2, F4, F6, F8 or c (continuous).*

To program, press the WARM/TEMP button, immediately followed by JETS/JETS I. Press WARM/TEMP button to adjust. Press JETS/JETS I to lock in selection. After locking in a D, N, OR DN may appear. If so, press WARM/TEMP until DN appears, and press JETS/JETS I to lock in selection.

## Spa Modes

**ST STD**

**Standard Mode** is programmed to maintain the desired temperature. Note that the last measured spa temperature displayed is current only when the pump has been running for at least 2 minutes. "ST" or "STD" will be displayed momentarily when you switch into Standard Mode. The temperature is constantly displayed when in Standard Mode. This is the best mode to use during COLD weather.

**EC ECN**

**WARM** heats the spa to the set temperature only during filter cycles or if the temperature falls to 20 degrees below set temperature. "EC" or "ECN" will display solid when temperature is not current, and will alternate with the temperature, when temperature is current. This is the best mode to use during WARM weather.

**SL SLP**

**WARM** heats the spa to 20 degrees below set temperature, only during filtration cycles. "SL" will display solid when temperature is not current, and will alternate with temperature when temperature is current, but only within 20 degrees of your set temperature.

## Freeze Protection

If the temperature sensors detect a drop to below 44°F/6.7°C within the heater, the pumps will automatically activate to provide freeze protection. The equipment stays on until 4 minutes after the sensors detect that the spa temperature has risen to 45°F/7.2°C or higher.

## Lights

Press the **Light** button on the topside control panel to turn the spa light on. If your spa has perimeter LED lights, they will also light up at the same time as the spa light. LEDs operate in four modes. The mode is changed by turning the light off and then immediately back on

- 1. Fading:** The lights will cycle through all the colors in this order: White, Cyan, Magenta, Blue, Chartreuse, Green, Red
- 2. Color Locked:** This cycle offers a hard color change without fading.
- 3. Quick Color Change:** Each time you press the button, you advance to the next color.
- 4. Flashing white:** The LED lights will flash white.



## One-Pump Spas



### Jets

Touch the “Jets” button once to turn the main 2-speed pump on or off, and to shift between low and high speeds. If left running, the low speed of the pump will automatically turn off after 2 hours, and the high speed will automatically turn off after 15 minutes.

### Warm/Cool

To display the Set Temperature, press either the “WARM” or “COOL” button once. The LCD will begin to flash the set temperature. If you want to increase or decrease the desired temperature, press the “WARM” or “COOL” button accordingly. Once at the desired temperature, allow a few seconds for the flashing to cease. Your Set Temperature has now been successfully set.

### MODE CHANGE

To change the mode on the spa, press WARM followed by LIGHT.

## One-Pump + Blower Spas or Two-pump (2-speed + 1-speed)



### Jets/Jets 1

Touch the “Jets or Jets 1” button to turn the main 2-speed pump on or off, and to shift between low and high speeds. If left running, the low speed of the pump will automatically turn off after 2 hours, and the high speed will automatically turn off after 15 minutes.

### Boost/Jets 2

The “Boost or Jets 2” button will operate the blower pump, if equipped, or the 1-speed pump.

### MODE CHANGE

To change the mode on the spa, press TEMP followed by LIGHT.

## Two-Pump + Blower Spas or Three-pump Spas (4 button topside)



### Jetg%

Press the “Jets 1” button to turn the main 2-speed pump on or off, and to shift between low and high speeds. If left running, the low speed of the pump will automatically turn off after 2 hours, and the high speed will automatically turn off after 15 minutes.

### Jet 2/Jet 3

Press the “Jet 2/Jet 3” button:

1. Once to turn Pump 2 On / Pump 3 Off
2. Again to turn Pump 2 On / Pump 3 On
3. Again to turn Pump 3 On / Pump 2 Off
4. Again to turn Pumps 2 & 3 Off

### MODE CHANGE

To change the mode on the spa, press TEMP followed by LIGHT.

### “Temp” Button

To display the Set Temperature, press the “TEMP” button once. The LCD will begin to flash the set temperature. To change the set temperature press the “TEMP” button again prior to the flashing timing out. The temperature will go either up or down. To change the temperature in the opposite direction wait for the LCD to stop flashing. Press the “TEMP” button again to resume the LCD flashing screen, and then press the “TEMP” button. Once at the desired temperature, allow a few seconds for the flashing to cease. Your Set Temperature has now been set.

## Operate Your Spa

### Two-Pump Spas and Two-Pump + Blower Spas (7 button oval topside)



#### Jets 1

Touch the “Jets 1” button once to turn pump 1 on or off, and to shift between low and high speeds. If left running, the low speed of the pump will automatically turn off after 2 hours, and the high speed will automatically turn off after 15 minutes.

#### Jets 2

Touch the “Jets 2” button once to turn pump 2 on or off and to shift between low and high speeds. If left running, pump 2 will automatically turn off after 15 minutes.

#### Option/Boost (if equipped)

This button is used to turn on the blower/pump in 3 pump spas. This is 1-speed only and will turn off automatically after 15 minutes.

#### Warm/Cool

To display the Set Temperature, press either the “WARM” or “COOL” button once. The LCD will begin to flash the set temperature. If you want to increase or decrease the desired temperature, press the “WARM” or “COOL” button accordingly. Once at the desired temperature, allow a few seconds for the flashing to cease. Your Set Temperature has now been successfully set.

#### MODE CHANGE

To change the mode on the spa, press WARM followed by MODE.

### Two-Pump Spas, Two-Pump + Blower Spas, and Three-Pump + Blower Spas (6-8 button rectangle topside)



#### Jets 1

Press the “Jets 1” button once to turn pump 1 on or off, and to shift between low and high speeds if equipped. If left running, the pump will turn off after a timeout period. The pump 1 low speed timeout on some systems may be as long as 4 hours.

On non-circ systems, the low speed of pump 1 runs when the blower or any other pump is on. It may also activate for at least 1 minute every 30 minutes to detect the spa temperature (polling) and then to heat to the set temperature if needed, depending upon mode. When the low speed turns on automatically, it cannot be deactivated from the panel; however, the high speed may be started.

#### Jets 2

Press the “Jets 2” button once to turn pump 2 on or off. If left running, the pump will turn off after a timeout period.

#### Jets 3 (optional on some systems)

Press the “Jets 3” button once to turn pump 3 on or off. If left running, the pump will turn off after a timeout period.

#### Blower/Boost (optional on some systems)

1-speed operation: on/off; If left on, the blower will automatically turn off after a timeout period.

#### Warm/Cool

To display the Set Temperature, press either the “WARM” or “COOL” button once. The LCD will begin to flash the set temperature. If you want to increase or decrease the desired temperature, press the “WARM” or “COOL” button accordingly. Once at the desired temperature, allow a few seconds for the flashing to cease. Your Set Temperature has now been successfully set.

## MODE CHANGE

To change the mode on the spa, first press MODE to enter mode programming. Press COOL to cycle through to desired mode (LCD flashes until confirmed), then press MODE again to confirm selection.

### Standard-In-Economy mode

Pressing JETS 1 while in Economy mode puts the spa in **Standard-In-Economy mode**, (“SE”) which operates the same as Standard Mode, then reverts to Economy Mode automatically after 1 hour. During this time, pressing “Cool” or “Warm” followed by “Light” will revert the mode to Economy immediately.

### Standby Mode

Pressing WARM or COOL followed by BLOWER or JETS 2 will turn off all spa functions temporarily. This is helpful when changing a filter. Pressing any button exits Standby mode. On some systems the “Jets 1” button will control the pump in Standby Mode (“Drain Mode”). In this case, press any other button to exit. System will revert to previous mode after 1 hour.

## Operational and Energy Tips

### I. Control Valves – air and water controls on the top of spa

- a. **Average to Cold Climate** - When not in the spa, make sure the valves are turned off. All these valves will inject a certain amount of air into the water which causes a cooling effect. Therefore your spa will have to heat more often and cost more money to operate.
- b. **Hot Climate** – Hot tubs are only designed to heat up and maintain temperature, therefore a hot climate can actually make a spa over heat. In these areas, the control valves can be left open all the time to help cool the spa down.

### 2. Filter Settings – Time and Duration

- To set your filter time, simply power your spa on at desired filter start time. If you power the spa up at 8:00am, it will filter at 8:00am and 8:00pm daily until the power is turned off and on again.
- If your electric provider offers different rate per KWH (peak/off-peak) then you will want your filter time to take place during off-peak time.
- If you are experiencing over heating with your spa, have the spa filter run during cooler times of the day, and leave the control valves opened like mentioned prior.
- The factory setting is F2, which means the spa will filter 2 hours for every 12 hour period. 4 hours total per day. Since we use a large primary pump for your filtration, it moves a lot of water quickly. Therefore we recommend you keep your filtration at no more than F4, anything longer will just waste electricity and in warm climates the spa may overheat.

### 3. Heating Modes – Standard, Economy, and Sleep

**- 4 Button Controllers Only** - These options are not always unlocked from the factory, and may require a settings change. Attempt to change the mode several times prior and if no results a dip switch will need changed.

**Standard** is the default setting, and you are in standard mode if none of the other setting codes show up

- Temperature will be at or near desired temperature constantly.
- Pumps turn on at regular intervals to check and maintain temperature.
- Best to use at startup of spa, it will heat until desired temperature is reached.
- Best to use in cold climates.
- Most costly to operate.

## Operate Your Spa

**Economy** is the power saving alternative for regular heating, you will know that you are in economy by the code displayed. If the pump is running the current temperature and code will alternate on the display.

- Spa will only heat during filter period
- Temperature will remain close to desired, but it will drop between filter periods
- If users can get in a routine, filter period should overlap the usage time by a half hour. This will have spa temperature closest to the desired temperature.
- Example, if using the spa at 8:00 have spa filter from 6:30 – 8:30.
- Best used in mild to warm climates
- Tests show a 20% reduction in energy consumption when compared to standard mode

**Sleep** is considered a vacation heater setting, and will maintain your spa water at the most affordable price.

- Spa will only heat during your filter period.
- The water temperature may drop up to 20 degrees below your desired temperature.
- Will work in all climates, and will not allow the spa to freeze.
- Tests show a 50%+ reduction in energy consumption when compared to standard mode.

### 4. Steam Loss/Venting Around Spa Cover

- It is normal to see an occasional burst of steam from around the cover due to pressure releasing from a high to low area. However heat loss can be greatly impacted by use of the spa
- Control valves should be turned off when getting out of the spa in a cool climate.
- Air injects from the cabinet and enters into the water area. That air not only will cool the cabinet area, but will also greatly increase the pressure under the cover and cause more steam to release.
- Surfaces are different for all spas, and covers may provide a better seal is spun differently.
- If the folding seam goes over the controller area, often more steam will be able to escape. Try to position the cover so that the fold seam goes over the wider top surface areas on the adjacent sides.

## Proper Spa Cover Use

Important! Keep the spa covered when not in use!

- Covered spas will use less electricity in maintaining your set temperature.
- Covering your spa will protect your spa's finish from the sun's ultraviolet rays.
- You are required to keep the spa covered to maintain warranty coverage.
- Covering your spa helps prevent children from drowning in the spa. See the photo for instructions on mounting the locks and how to lock and unlock the cover.
- In addition, while a soft spa cover is rigid, it is not designed to support any weight. Therefore, as a safety precaution and to preserve the life of your cover, you must not sit, stand, or lie on it, nor should you place objects of any kind on top of it.

## Personal Settings

### Jets



Most jets in your spa are adjustable. Rotating the face of an **adjustable jet** to the left (counter-clockwise) will increase the amount of water flow through the jet. Rotating the face of an adjustable jet to the right (clockwise) will decrease the amount of water flow through the jet.



**Neck jets** can be turned on and off using the nearby **water on/off knob**.



**Blower jets** are not adjustable, but can be turned on and off using the **Aux** or **Option** button on your Control Panel.

## Air Controls



Air controls are the **2" knobs** located around the top of your spa. Each one will let you add

a mixture of air with the jet pressure. This is accomplished by rotating the air control knob to the left (counterclockwise) to increase the amount of air-flow through the jets. To decrease the amount of air-flow through the jets, rotate the handle to the right (clockwise).

## Diverter Knobs (if equipped)

Diverter knobs are 3" knobs located around the top of your spa. They allow you to divert water through jets from one side of the spa to the other, or in most cases from floor jets to wall jets. This is accomplished by rotating the diverter knob to the left (counterclockwise), decreasing the amount of water flow through a section of jets. To increase the amount of water flow through the other section of jets, rotate the handle to the right (clockwise).



## Water Feature Controls (if equipped)



Some spas include waterfalls and/or water columns. Increase or decrease the flow

of the waterfall using the **2" water on/off knob** nearest the water feature.



### **IMPORTANT! (Water Features)**

When spa session is over, and before cover is closed, **these water features MUST be turned off using the water control knob nearest the feature** or water will continue to run through them, potentially causing draining of your spa, depending on how long they are left on.

## Testing and Adjusting Water Chemistry

- As the owner of a spa, it is important that you maintain your spa water and keep your spa equipment in excellent condition. To do so, you must first balance your spa water.

- You will need to test and adjust the chemical balance of your spa water. Although this is not difficult, it needs to be done regularly.

There are 2 types of testing methods:

- The reagent test kit is a method which provides a high level of accuracy. It is available in either liquid or tablet form.

- Test strips are a convenient testing method commonly used by spa owners.

## Balancing the Total Alkalinity

- Total alkalinity (TA) is the measure of the total levels of carbonates, bicarbonates, hydroxides, and other alkaline substances in the water. TA can be considered a pH buffer. It is the measure of the ability of the water to resist changes in pH level.

- **The recommended total alkalinity is 80 - 120 ppm.**

- If the TA is too low, the pH level will fluctuate widely from high to low. Low TA can be corrected by adding alkalinity increaser.

- If the TA is too high, the pH level will tend to be too high and may be difficult to bring down. High TA can be corrected by adding pH decreaser.

- When the TA is balanced, it normally remains stable, although adding water with high or low alkalinity will raise or lower the TA level.

## Balancing the Calcium Hardness

- Calcium hardness (CH) is a measure of the total amount of dissolved calcium in the water. Calcium helps control the corrosive nature of the spa's water and is why soft water is not recommended. The low calcium content of soft water is very corrosive to the equipment and can cause staining of the spa shell.

- **The recommended calcium hardness is 150 - 200 ppm.**

- If the CH is too low, add liquid hardness increaser.

- If the CH is too high, dilute the spa water with soft water or, if this is not available, add stain and scale defense.

- When the CH is balanced, it normally remains stable, although adding soft water or very hard water will raise or lower the CH level.

## Balancing the pH

- The pH level is the measure of the balance between acidity and alkalinity.
- **The recommended pH is 7.2 - 7.6.**
- If the pH is too low, it can cause corrosion of metal fixtures and the heating element.
- If the pH is too high, it can cause scaling by allowing metals or minerals to form deposits and stain spa surfaces.

Too alkaline, causes scaling	8.2	↓ Decrease the pH level.
	8.0	
	7.8	
Ideal balance	7.6	
	7.4	
	7.2	
Too acidic, causes corrosion.	7.0	↑ Increase the pH level.
	6.8	
	6.6	

## Ozone

Ozone is a natural purifier. Chemically known as O<sub>3</sub>, it is produced from simple oxygen molecules in our atmosphere. Ozone is produced in nature from lightning during electrical storms and from ultraviolet rays from the sun. It forms our protective ozone layer. Your spa's ozone generator is designed to duplicate this natural sanitizer. Ozone breaks down and oxidizes oils, suntan lotions, sweat, urea, etc. from spa water more effectively than commercial oxidizers. Ozone works with chlorine or bromine systems in your spa to destroy bacteria and viruses and will do so more effectively. Ozone only leaves simple oxygen in the water as a by-product. If your spa is equipped with an ozone generator it will automatically produce ozone, but it cannot be used as the sole means of maintaining safe spa water. You must select and use a spa chemical sanitizer in addition to your ozone generator. The ozone generator is a wearable, non-warranty item and it needs to be replaced approximately every 2 years.

## Sanitation

You will need to decide which chemical sanitizer you wish to use, regardless of the presence of an ozonator. Spa owners with an ozonator still need to use a chemical sanitizer. Sanitizers kill bacteria and viruses and keep the water clean. A low sanitizer level will allow microbes to grow quickly in the spa water. Use either bromine or chlorine as your sanitizer or a non-chlorine/non-bromine sanitizer. All work well when maintained regularly. Consult your spa dealer for the right decision with regards to your lifestyle and spa usage.

**NOTE:** This manual will cover general chlorine sanitation only.

## If Using Chlorine as a Sanitizer

- Do not use Tri-chlor tablets or liquid chlorine.
- Once a week, check the chlorine level using either a test strip or a reagent kit. Refer to product for the ideal range.
- Monitor chlorine levels of the spa water weekly. Note that chlorine dissipation rate will be faster at higher water temperatures and slower at lower temperatures.
- When you add chlorine, make sure no bathers are in the spa, open all jets and run the spa at high speed with the cover open for at least 30 minutes.

## If Using Bromine as a Sanitizer

- Bromine is a very effective sanitizer that produces low chemical odors. Unlike chlorine, it can break down bacteria and other impurities to a safe level with a low burn-out rate.

## Shocking the Water

- In addition to using a chemical sanitizer, you may need to shock the water. Shocking the water helps remove burned-out chemicals, bacteria, and other organic material from your spa's water and improves your sanitizer's effectiveness.
- Do not use chlorinating shock, which will damage your spa's jets and pump seals. Only use an oxidizer shock. It is an easy way to maintain chemical plans.
- For best results use the directions below.

### Add oxidizer shock:

- If sanitizer level temporarily reads low
- After heavy bather loads
- If water has a strong odor

**Spa must be running with all of the jets on high for 30 minutes with the cover open. If necessary, repeat oxidizer shock in 30 minute intervals.**



The manufacturer does hereby claim no responsibility or liability for use of and quantities of the chemicals used. Read and follow all label instructions.

**Do not use third-party salt-based systems in your spa! Damage caused by salt-based systems that have not been factory installed will not be covered under your warranty.**

### Filtration

Cleaning your filter regularly is the easiest and most effective single thing you can do to keep your water clear. A clogged or dirty filter will cause the heater and pump to work harder than they need to, possibly causing them to fail. The spa's heating system will only function with the proper amount of water flow through the system.

### Filter Cleaning

The filter is the part of your spa that removes the debris from the water and needs to be cleaned on a regular basis to maximize your spa's filtering performance and heating efficiency.

In addition to spraying off the filter weekly to remove surface debris, your filter should be deep cleaned periodically to dissolve scale and particles that get lodged deep within the filter fibers and impede the filtration process. Even if the filter looks clean, scale and particles can clog the fibers and prevent water from flowing through the filter resulting in the most common spa problem – no heat, caused by a dirty filter.

We recommend you clean your filter once a month and replace it once every 6 months or as necessary.

- Remove the filter with the spa off.
- Place the dirty filter into a bucket of water deep enough to cover the filter. Add 8 oz of liquid filter cleaner to the bucket of water.
- Soak the filter for a minimum of 24 hours.
- Spray pleats of the filter with a water hose.
- Reinstall the filter.

**Tip:** Keep a spare filter to use in the spa while the dirty filter is being deep cleaned.

## Maintenance Schedule

### *Each time you refill the spa*

- Follow the Filling and Starting procedure, sections 7-10 on page 12.

### *Prior to each use*

- Test the spa water using either test strips or a reagent test kit. Adjust chemical levels as necessary.

### *Once a week*

- Test the spa water using either test strips or a reagent test kit. Adjust chemical levels as necessary.

### *Once a month*

- Deep clean your spa's filter.
- Apply spa vinyl cleaner/protectant to vinyl spa soft cover and pillows.

### *Every 3-4 months*

- Drain and clean your spa with non-abrasive cleaner.
- Polish shell with acrylic surface cleaner.
- Follow the Filling and Starting procedure, sections 7-10 on page 12.

### *Once a year\**

- Replace filter cartridge(s) if the pleats appear frayed or damaged.

\*May require more frequent replacement, depending on use.

### *Every 2 years*

- Replace your ozonator.

## Vacation Care

You can leave your spa unattended for up to two weeks if you follow these instructions.

- ALWAYS lock your cover using the cover locks if you plan to be away from home and the spa is filled with water.
- Follow the water quality instructions starting on page 20.
- Shock the water (add either chlorine or bromine sanitizer).
- When you return, check water chemistry and adjust accordingly.
- **If you will not be using your spa for longer than 14 days and a spa maintenance service is not available, we strongly recommend you drain and winterize your spa. See page 26 for Winterization Procedure.**

## Chemical Safety

Read and follow all printed instructions listed on bottles and packages. Failure to follow chemical directions may result in serious injury, sickness, or even death.

Add chemicals to the center of the spa with the pump running. Make sure the water is heated. Never add chemicals to cold water, as this will effect chemical action. Also, never add chemicals directly into the skimmer.



### **WARNING!**

**Never add chemicals to your spa while bathers are in the spa!**



**Do not exceed chemical dosages as recommended on chemical bottles and packages.**



**Never change chemical brands or types without completely draining, flushing and thoroughly cleaning the spa and cover first.**



### **WARNING!**

**Never mix chemicals together.**



**Do not allow chemicals to come in contact with skin, eyes or clothing. Remove and wash clothing that may have been exposed to chemical contact prior to wearing them again.**



**Inhaling or ingesting chemicals will cause serious injury, sickness, or even death.**



**Chemicals must be stored completely out of the reach of children in an area that is well vented, cool, and dry. Failure to provide a proper area for chemical storage may result in serious injury, sickness, fire explosion and even death. Do not store your chemicals inside the equipment area of your spa.**



## Draining Your Spa

Your spa should be drained every 3-4 months, and refilled with fresh tap water. The following is the recommended method for draining your spa.

1. Turn off the power at the breaker.
2. Remove filter.
3. Your drain valve is located inside the spa cabinet on the Service Access Side.
4. Locate hose ending with the 3/4 inch hose shut-off valve.
5. Hook up the female end of a garden hose to the drain fitting.
6. Place the other end of the garden hose where you would like the water to drain to.
7. Twist the hose shut-off valve counterclockwise to open the drain.
8. Let spa drain completely, then remove garden hose.
9. Twist the hose shut-off valve clockwise to close it and replace cap.



Water drained from your spa is safe to dispose of in your yard, septic system or in a drain. Follow all local/municipal codes and regulations for disposal.

## Cleaning Your Spa

### Acrylic Spa Shell

Each time you drain your spa, before you refill it you should clean your spa shell with a low detergent, non-abrasive cleaner specifically formulated to clean the spa without damaging its acrylic finish.

1. Spray cleaner directly to the spa's finish.
2. Wipe clean with a soft cloth.
3. Repeat on heavily calcified areas.
4. Wipe spa thoroughly with a wet sponge, rinsing often in a bucket of clean water.
5. Allow the spa to dry completely.

*IMPORTANT: Do not use any of these products on spas full of water. Only apply to clean, cool, dry surfaces. In-correct product usage may cause water issues.*

### Resin Spa Surface

For normal care and cleaning, use a soft cloth or sponge with soap and water. Rinse well and dry with a soft, clean cloth.

- Clean grease, oil, paint and ink stains with isopropyl (rubbing) alcohol. Rinse well and dry with a soft, clean cloth.
- Never use abrasive cleaners.
- Do not allow your surface to come into contact with nail polish, nail polish remover, wintergreen oil (methyl salicylate), dry cleaning solution, lacquer thinners, gasoline, pine oil, etc.
- Avoid placing razorblades or other sharp instruments on this surface as they may scratch it. Small scratches can be removed by buffing lightly with a clean cloth and using either an automotive polishing liquid or a toothpaste containing a fine polishing ingredient. For deeper scratches, sand the surface lightly with 400 grit "wet or dry" paper and buff with fine-grit buffing compound.

### Removing and Reseating the Pillows

You can remove the pillows for cleaning and maintenance quickly and easily. This method works for all types of pillows.

#### To attach 'U'-shaped pillows:

Press plugs gently into sockets.

#### To remove 'U'-shaped pillows:

Pull gently upward on pillow.

#### To attach rectangular pillows:

1. Hold pillow LOWER than the final pillow position.
2. Drag the pillow UPWARD allowing the BOTTOM of the bracket to enter the slot in the pillow first.
3. As the pillow begins to attach to the bracket, press inward on the center of the pillow with your fingers.
4. The pillow will snap into place.



## Cleaning and Care

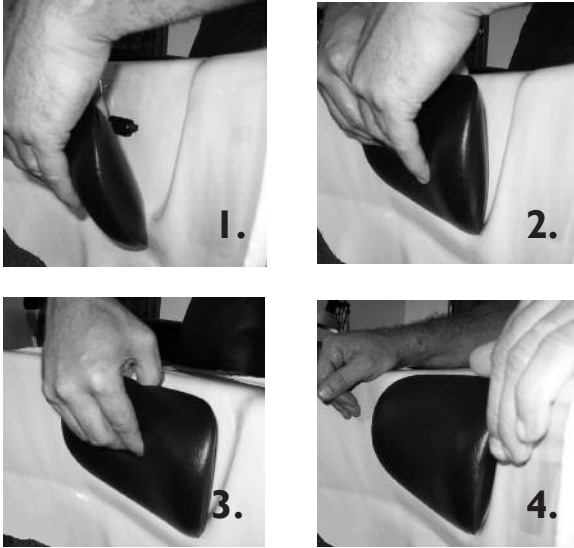

### Spa Cover and Pillows

Protect spa cover and pillows by applying a spa vinyl cleaner as part of your monthly maintenance plan. It is specifically designed to protect spa covers and pillows from chemical and ultraviolet light damage without leaving an oily residue behind.

*Warning: Do not use automotive vinyl protectants on spa covers or pillows. These products are generally oil-based and will cause severe water clarity issues that are difficult to correct.*

## Sound System Feature

(if equipped)

Marine grade stereo options are available. Spas equipped with an audio system are delivered with the manufacturer's operating instructions. Also:

- Make sure that hands are dry before use.

- Water damage is not covered by spa manufacturer or the sound system manufacturer's warranties.
- The system is water resistant but NOT water-proof. Take every precaution to keep this system dry. Water damage is not covered by spa manufacturer or sound system manufacturer's warranties.

### Bluetooth Stereo Instructions



1. Locate silver button on front panel of spa cabinet exterior.

2. Press silver button and listen for tone. Stereo is in pairing mode.

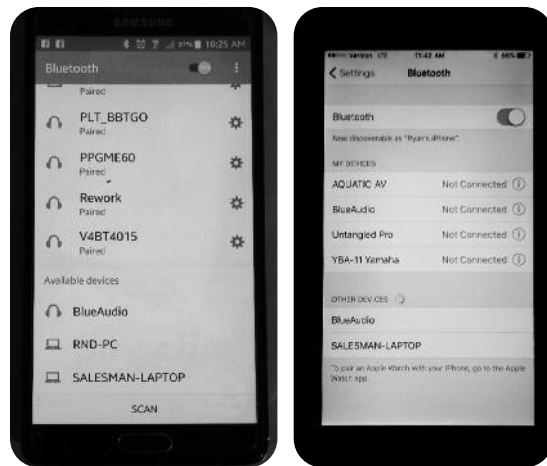

3. Connect Bluetooth device by scanning for devices and selecting BlueAudio.

4. Pair using code 0,0,0,0



### AUDIO EQUIPMENT RISK OF ELECTRIC SHOCK

- "CAUTION – Risk of Electric Shock. Do not leave compartment door open";
- "CAUTION – Risk of Electric Shock. Replace components only with identical components"; and
- "Do not operate the audio/video controls while inside in the spa".
- "WARNING – Prevent Electrocutation. Do not connect any auxiliary components (for example cable, additional speakers, headphones, additional audio/video components, etc.) to the system".
- These units are not provided with an outdoor antennae; when provided, it should be installed in accordance with Article 810 of the National Electrical Code, ANSI/NFPA 70
- Do not service this product yourself as opening or removing covers may expose you to dangerous voltage or other risk of injury. Refer all servicing to qualified service personnel.
- When the power supply connections or power supply cord(s) are damaged; if water is entering the audio/video compartment or any electrical equipment compartment area; if the protective shields or barriers are showing signs of deterioration; or if there are signs of other potential damage to the unit, turn off the unit and refer servicing to a qualified service personnel.
- This unit should be subjected to periodic routine maintenance (for example, once every 3 months) to make sure that the unit is operating properly.

# Winterization Procedure

**Important: Damage caused by improper winterization is not covered under the manufacturer's warranty.**

1. Turn off power at the GFCI circuit breaker before draining or servicing your spa.
2. Remove exterior resin panels by inserting a flathead screwdriver at the bottom edge of the panel and prying out (Figure 1) or by prying out decorative plugs and unscrewing screws on UltraTec panels.
3. Attach a garden hose to the drain and open the blue ball valve (Figure 2). Water will start to drain. You may have some water left in the spa shell that did not drain. Remove it with a wet-vac or by hand with a small cup.

Water drained from your spa is safe to dispose of in your yard, septic system or in a drain. Follow all local/municipal codes and regulations for disposal.

4. Loosen all large white unions from heater and pump(s) to let excess water drain from the lines (Figure 3). **Your spa may have more than one pump. Be sure to follow winterization procedures for each pump and all unions. A one-pump spa has 4 unions; a two-pump spa has 6.**
5. After the spa has drained, you MUST also use a wet-vac to remove the water from the lines by vacuum/suction. Water left in the lines and jets will freeze and damage them.

To adequately clean out the lines, place the wet-vac for 10-15 seconds over: each drain (Figure 4); each union (Figures 5 and 6); each jet face (Figure 7); each suction (Figure 8); and the filter cavity (Figure 9). See *filter removal procedure*.

6. Tighten all unions and make sure all gate valves are open with clips insatalled (Figure 3).
7. Pour a gallon of spa antifreeze into the top of each pump (Figure 10) and a gallon into the filter cavity (Figure 11).
8. Replace all exterior panels.
9. Close your spa cover.

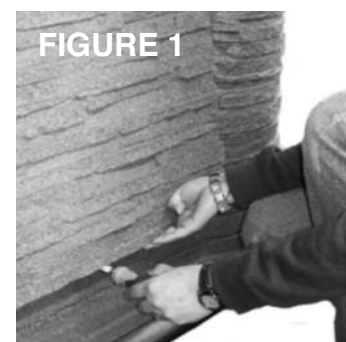

FIGURE 1

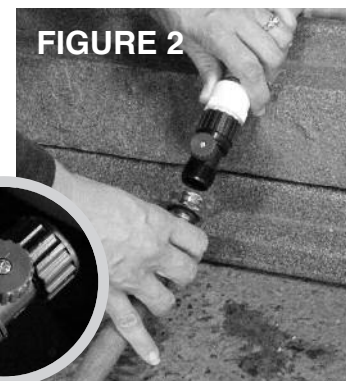

FIGURE 2

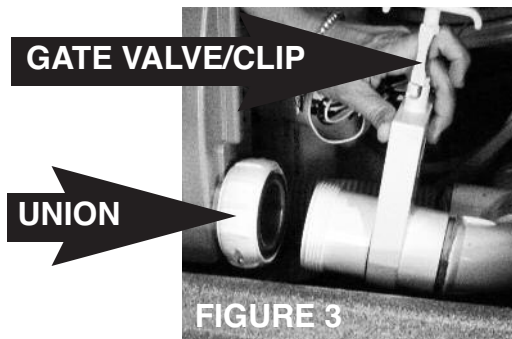

FIGURE 3



FIGURE 4



FIGURE 5

## Winterizing and De-Winterizing Your Spa



**Important: Damage caused by improper winterization is not covered under the manufacturer's warranty.**

**If you have any questions, please call Technical Support at 1-800-787-6649.**

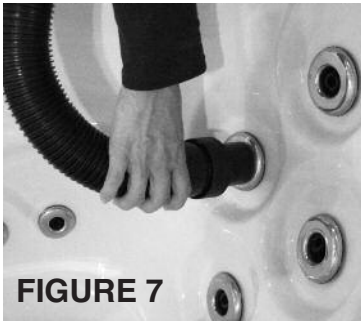

**You may also wish to contact a professional to perform these services for you.**



---

## De-Winterization Procedure

1. Fill the spa's footwell with water.
2. Drain the spa to clear the antifreeze out of the spa. See page 24. *Draining Your Spa*, for procedure.

*Water drained from your spa is safe to dispose of in your yard, septic system or in a drain. Follow all local/municipal codes and regulations for disposal.*

## Troubleshooting Water Quality Problems

<b>Problem</b>	<b>Probable Causes</b>	<b>Possible Solutions</b>
<b>Water is cloudy</b>	<ul style="list-style-type: none"> <li>• Dirty/Misaligned filter</li> <li>• Inadequate or improper sanitizing</li> <li>• Oils, lotions, organic matter, Bio-Film, scaling</li> <li>• Old water</li> <li>• Improper pH, alkalinity, calcium hardness levels</li> <li>• Metals present within water</li> <li>• Recent high bather load</li> </ul>	<ul style="list-style-type: none"> <li>• Clean/Adjust or Replace the filter</li> <li>• Test/Adjust sanitizer levels</li> <li>• Flush/Purge spa system</li> <li>• Drain, clean and refill spa</li> <li>• Test/Adjust pH, alkalinity, calcium hardness levels</li> <li>• Use a Metal Sequestrant</li> <li>• Shock the spa</li> </ul>
<b>Algae</b>	<ul style="list-style-type: none"> <li>• Leaving spa uncovered</li> <li>• Sanitizer too low</li> <li>• pH too high</li> <li>• Bad filtration</li> </ul>	<ul style="list-style-type: none"> <li>• Keep Spa covered when not in use</li> <li>• Test/Adjust sanitizer levels</li> <li>• Test/Adjust pH levels</li> <li>• Clean/Adjust or Replace the filter</li> <li>• Shock the spa</li> <li>• To prevent algae use an algacide</li> </ul>
<b>Organic buildup or scum ring around spa</b>	<ul style="list-style-type: none"> <li>• Dirty/Misaligned filter</li> <li>• Oils, lotions, organic matter</li> <li>• Metals present within water</li> <li>• Improper pH calcium hardness levels</li> </ul>	<ul style="list-style-type: none"> <li>• Clean/Adjust or Replace the filter</li> <li>• Flush/Purge spa system</li> <li>• Use a Metal Sequestrant</li> <li>• Test/Adjust pH, calcium hardness levels</li> <li>• Wipe off scum ring using a clean rag. You may need to drain, clean and refill your spa.</li> </ul>
<b>Chlorine odor</b>	<ul style="list-style-type: none"> <li>• Chlorine level too high</li> <li>• pH too low</li> </ul>	<ul style="list-style-type: none"> <li>• Test/Adjust sanitizer levels</li> <li>• Test/Adjust pH</li> </ul>
<b>Musty odor</b>	<ul style="list-style-type: none"> <li>• Algae or bacteria</li> <li>• Inadequate or improper sanitizing</li> <li>• Oils, lotions, organic matter, Bio-Film</li> <li>• Improper pH levels</li> <li>• Recent high bather load</li> </ul>	<ul style="list-style-type: none"> <li>• Shock the spa</li> <li>• Test/Adjust sanitizer levels</li> <li>• Flush/Purge spa system</li> <li>• Test/Adjust pH</li> <li>• Drain, clean and refill spa</li> </ul>
<b>Eye irritation</b>	<ul style="list-style-type: none"> <li>• Improper pH levels</li> <li>• Inadequate or improper sanitizing</li> </ul>	<ul style="list-style-type: none"> <li>• Adjust pH to balance</li> <li>• Test/Adjust sanitizer levels</li> </ul>
<b>Skin irritation or rash</b>	<ul style="list-style-type: none"> <li>• Inadequate or improper sanitizing</li> <li>• Sanitizer level too high</li> <li>• Bacterial contamination</li> </ul>	<ul style="list-style-type: none"> <li>• Test/Adjust sanitizer levels</li> <li>• Shock spa</li> <li>• Allow level to drop naturally to below 5 ppm before using spa</li> <li>• Flush/Purge spa system, replace the filter, drain, clean and refill spa</li> </ul>
<b>Stains</b>	<ul style="list-style-type: none"> <li>• Typical dirt and grime</li> <li>• Improper pH, alkalinity, calcium hardness levels</li> <li>• Calcium build-up</li> <li>• Rust/Corrosion</li> </ul>	<ul style="list-style-type: none"> <li>• Drain, clean and refill spa</li> <li>• Test/Adjust pH, alkalinity, calcium hardness levels</li> <li>• Use stain and scale inhibitor</li> <li>• Use a Metal Sequestrant</li> </ul>
<b>Scale</b>	<ul style="list-style-type: none"> <li>• Improper pH, alkalinity, calcium hardness levels</li> <li>• Metals present within water</li> <li>• Oils, lotions, Other contaminants</li> </ul>	<ul style="list-style-type: none"> <li>• Test/Adjust pH, alkalinity, calcium hardness levels</li> <li>• Use a Metal Sequestrant</li> <li>• Flush/Purge spa system</li> <li>• Drain, clean and refill spa</li> <li>• Use stain and scale inhibitor</li> </ul>

# Troubleshooting Operations

## No Power (Breaker Tripping Constantly)

### 1. Verify wiring of the GFCI breaker. (New Installs Only)

- The neutral wire to the spa must be connected to the GFCI breaker, not a neutral bus bar.
- If neutral wire is not connected directly into the breaker, the breaker will not turn on.

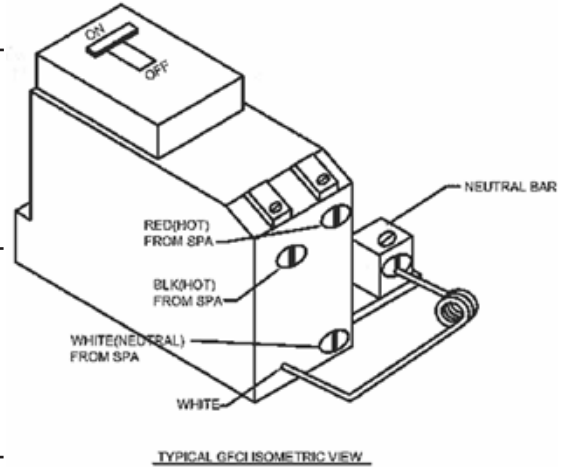

### 2. Look for leaks.

- Inspect the inside of the cabinet looking for any sign of a leak.
- If water is leaking onto an electric component it may cause the breaker to trip.

### 3. Test each individual component. (pumps, blower, ozone, lights, stereo, heater)

- To test each component, disconnect one plug at a time and try the breaker.
- When the breaker holds, the disconnected component is the cause of the issue.
- Replace component.

### 4. Test the spa GFCI breaker.

- To test the GFCI breaker, remove the incoming electrical wires from the spa pack.
- Once all wires are removed, turn on breaker.
- If breaker continues to trip without spa connected, replace breaker.

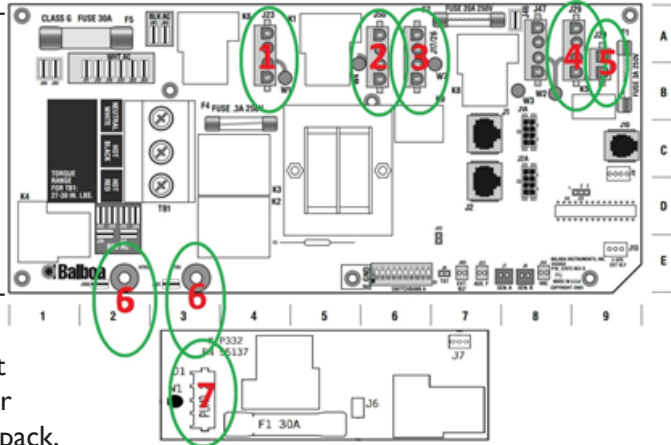

### 5. Replace the spa pack.

- If the spa is wired properly, each component tests to be in working order, and the breaker holds when spa is disconnected, replace spa pack.

## No Power (Breaker Holding - No Display/Response)

% 7 \ \ W \ j c \ H \ U \ Y \ t c \ h \ Y \ g d U"  
 U' 7 \ \ W \ t c \ a \ U \ Y \ g \ f \ Y \ g d U \ \ U \ g \ h \ Y'  
 d f c d Y f \ j c \ H \ U \ Y \ h \ h \ Y \ h \ Y \ f a \ ] b U \ V \ c \ W \'  
 k \ h \ ] b \ h \ Y \ g d U \ d \ U \ W \'"

### 2" Inspect .3 amp fuse"

- Turn power off at breaker/cord.
- Remove fuse from circuit board of spa.
- Test fuse for continuity.
- If fuse is blown, replace with a .3amp up to .5 amp fuse.

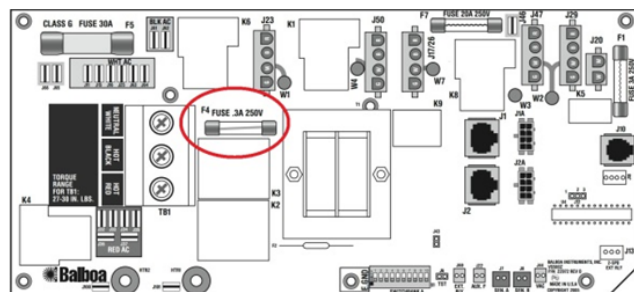
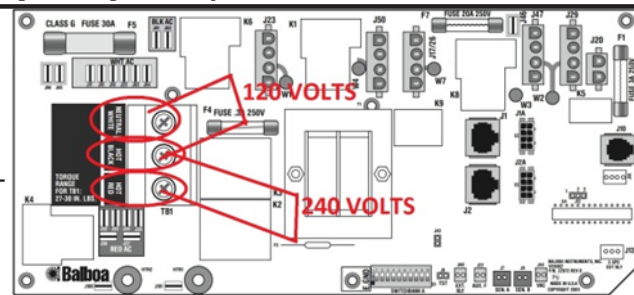

## No Power (Breaker Holding - No Display/Response) cont.

### 3. Test topside control.

- Turn off power at breaker/cord.
- Unplug topside control from circuit board.
- Turn on breaker/cord.
- Wait up to 20 minutes.
- If spa pumps turn on, replace topside control.

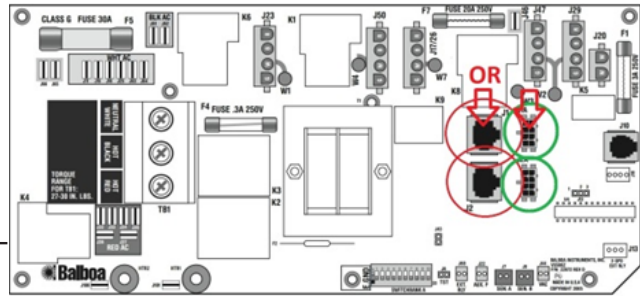

### 4. Replace the spa pack.

- If the spa has the proper voltage, the .3 amp fuse is good, and after 20 minutes the spa fails to turn anything on, replace spa pack.

## Pump/Blower Not Operating

### 1. Verify topside button is functioning.

- When topside button is pressed, inspect button led for illumination.
- When topside button is pressed it should cause a relay in the electrical pack to activate making a “clicking sound”.
- If button is failing to illuminate and relay is not activating topside may need replaced.



### 2. Inspect 30 amp/20 amp fuse.

- Each pump/blower will have its own fuse. (when a spa has three water pumps pump 2 and 3 share a 30 amp fuse).
- Turn power off at breaker/cord.
- Remove fuse from circuit board of spa.
- Test fuse for continuity.
- If fuse is blown replace with identical replacement.

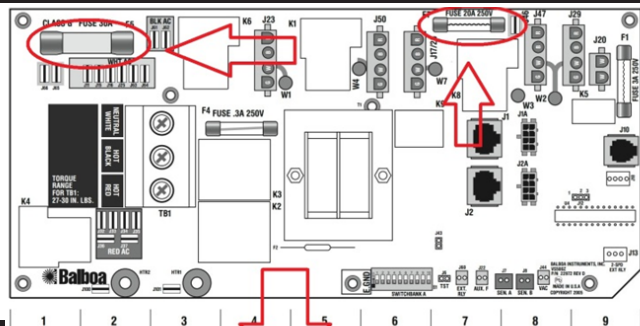

### 3. Test voltage to pump.

- Test voltage from pump plug in port, when pump should be running.
- Check voltage between the top leg (red) and the third leg (white) for high speed voltage.
- Check voltage between the second leg (black) and the third leg (white) for low speed.
- If voltage provided to pump is proper, replace pump.

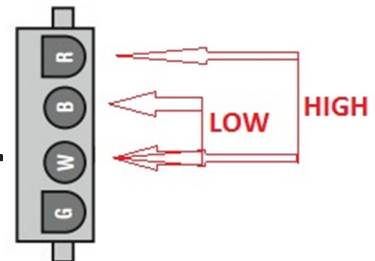

### 4. Test a working component.

- If unable to test the voltage or to double check your findings, you can use another pump or blower that is currently functioning and plug it into the port the non working pump is plugged into to test it.
- You can also plug the non working pump into a port that is known to be functional and press to corresponding button to test the non working pump.

### 5. Check voltage to spa.

- Check to make sure spa has the proper voltage at the terminal block within the spa pack.
- Another way of checking the voltage is to turn the spa off and then back on.
- As the spa powers up it will display its three programming codes, the power the spa is receiving, and pr. 12 indicates 120 and 24 indicates 240. (example: 100, 63, 43, 12, pr)

## Troubleshooting Operations

### Pump/Blower Not Operating cont.

#### 3. Replace the spa pack.

a. If the topside button is illuminating, the fuse is good, the spa has the proper voltage, but the pump plug port is providing incorrect or no voltage to the pump, or if the spa pack is providing voltage to both high and low speed at the same time, replace the spa pack.

### Spa failing to heat

#### 1. Any codes?

- On the display of the spa there may be codes that may indicate as to why the spa is failing to heat such as (hh, oh, ic, sa, sb, sn, hl, lf, dr, dy, ec, sl, ohh, ohs, sna, snb, sns, hfl, dry, ice, ecn, slp, se).
- Hh, oh, hl, lf, dr, dy, ohh, ohs, hfl, dry are flow codes indicating that there is an inadequate amount of water flow through the heater tube. See flow issues.
- lc, ice are potential ice condition codes. This indicates that the temperature of the water is approaching freezing conditions. This will not allow the heater to turn on until the temperature of the spa exceeds 45 degrees. Add warm water to the filter area until temperature of spa increases above 45 degrees or until heater engages.
- Sa, sb, sn, sna, snb, sns are sensor codes indicating that there is an issue with one or both sensors. Sa and sna indicate sensor a is having an issue. Sb and snb indicate sensor b is having an issue. Sn and sns indicate the sensors are out of balance. Swap where the sensors plug into the circuit board. If the code changes the issue is with the individual sensor. If the same code persists, replace pack.
- Ec, sl, ecn, slp, se are indicating the mode the spa is in. If the spa is not in standard mode it may not maintain the desired temperature. Change the heating mode to standard mode.

#### 2. Is the spa calling for heat?

- On the topside control there is an led by the warm, cool or temperature button. If this light is on, the spa is calling for heat. If it is not, the spa is not trying to heat.



#### 3. Check voltage to spa.

- Check to make sure spa has the proper voltage at the terminal block within the spa pack.

#### 4. Test voltage to the heater.

- Test the voltage being provided to the heater by testing between the two copper straps connecting the heater to the circuit board. The heater should have the exact same voltage the spa is receiving.

#### 5. Replace heater/pack.

- If there are no codes on the display, the spa is set to standard mode, the heater led light is illuminated, the spa pack is receiving the proper voltage, but the heater is not, replace the pack.
- If the heater is receiving the proper voltage, replace the heater.





### Spa overheating

#### 1. **Why a spa overheats.**

- a. Spas are designed to get hot and do not contain a cooling system.
- b. A spa can over heat if the outside temperature is hot, the spa is in direct sunlight, the filtration cycle is set too high, or a possible stuck relay on the circuit board.

#### 2. **Outside temperature/direct sunlight.**

- a. If the outside temperature is too high, it will heat the spa in addition to the heater within the spa.
- b. To cool the spa down the mode can be changed to economy or sleep, the air valves can be opened, or the cover may be left off for a short period of time to allow the excess heat to escape.

#### 3. **Filtration cycle settings.**

- a. If the filtration cycle setting is set too high the pump will run more building up excess heat within the cabinet of the spa.
- b. This heat is then transferred into the water and overheats the spa.
- c. Adjust the filtration cycle settings to f2 or fil2.

#### 4. **Stuck relay.**

- a. When a relay becomes stuck on the circuit board for the heater it will not allow the heater to turn off.
- b. If this is the issue, when the pump turns off the heater will continue running and overheat within its tube.
- c. When this occurs, the spa shuts down and stops heating displaying a flow code. This is rare but can happen.
- d. If a relay is determined to be the cause of the issue replace pack.

### Flow issues

#### 1. **Determine extent of flow issue.**

- a. First determine if flow issue is with one individual jet, multiple random jets, or an entire section of the spa.

#### 2. **Individual jet/multiple random jets.**

- a. If one single jet is failing to flow properly, first make sure the jet is open by rotating it counter-clockwise.
- b. Note: the ozone jet cannot be closed.
- c. If this fails to work there is either something stuck in it preventing flow or a kinked hose.
- d. Inspect for kinked hose.
- e. If hose is not kinked remove jet insert.
- f. Once insert is removed any obstruction should flow out into the spa.
- g. Return jet insert to spa.

#### 3. **Entire section of spa.**

- a. For each pump within the spa there are two gate valves. Make sure these are fully open with retainer clip installed.
- b. If spa is equipped with a water divertor valve, make sure the valve is in the correct direction allowing water flow to the designated area.
- c. If the spa has more than one jet/boost button, make sure all pumps have been activated.
- d. Check to see if the spa has a hidden jet/boost button. If so replace overlay.
- e. If section of spa in question is connected to pump 1, inspect filter for cleanliness and make sure it is free of debris.
- f. If the filter appears to be expanding, cracking the top or bottom of the filter plastic, or the filter is needing to be replaced more frequently than normal; inspect filter canister for proper direction of flow.
- g. The pump connected to the section of plumbing may have an air lock.
- h. If the pump is failing to turn on at all see pump/blower not operating section.

## Troubleshooting Operations

### Unresponsive controls

#### 1. "8YHfa JbYVI H/bhcZ]gg Y"

U" First determine if 1 button is failing to operate, all buttons fail to operate, the display is blank, any codes are present, buttons do not operate proper components, or the screen is constantly cycling.

#### 2. %Vta dcbYbhVI Hrcb"

U" If one component button is failing to operate, first unplug and plug in topside.

V" Inspect fuse and component port for power.

W" If no power and fuse is good, replace topside.

X" Note: if the issue is that pump 2 will no longer operate on two speeds, see strell 5b programming instructions.

#### 3. %bcb!Vta dcbYbhVI Hrcb"

U" If button failing to work is a non component button such as warm, cool, temp, or mode replace topside after unplugging and plugging back in fails to resolve issue.

#### 4. 5`Vi Hrcbg'

U" If all buttons are failing to operate, first unplug and plug in topside.

V" If this fails to resolve the issue but the spa is still continuing to run on its own, replace topside.

#### 5. 6`Ub\_X]gd`Urh'

U" If the display is blank, first unplug and plug in topside.

V" If this fails to resolve the issue but the spa is still continuing to run on its own, replace topside.

#### 6. 7cXYgcb X]gd`Urh'

U" If there are any codes on the display, see codes section.

#### 7. 6i HrcbgjcdYfUHY`JbVzffYMin'

U" If the buttons on the topside all work but operate the incorrect components, first make sure the topside overlay is not installed upside down.

b" Inspect dip switches for proper settings.

#### 8. 8]gd`UmVcbgUohmMM]b["

U" If the screen is constantly cycling between the filtration cycles, the heating modes, the temperature is constantly going to 104 or 80 and blinking, or if a component light is constantly flashing on/off, there is most likely a stuck button on the topside. If so replace topside.

b" Note: this does not include when the spa is in sleep or economy mode and the topside will flash between the current temperature and either ec or sl for the mode it is in.

#### 9. GfY%) Vdfc[fUa a ]b[ ]bgfi V]cbg'

U" With spa on, flip dipswitch 10 into the on (up) position.

V" Use cool button to locate the setting you want to change. This may require pressing the button multiple times. (example: p2.e)

W" Press jets to edit this menu. Anything that can be changed in the programming will flash.

X" Use cool to change flashing number or letter. (use 15b manual to see what each setting is)

Y" Press jets to finish editing.

f. With spa still on, flip dipswitch 10 back into the down (off) position. Spa will restart.

g. Test spa to make sure everything is working properly.

### Stuck valve

**1. Do not open valves while spa is on!!!**

U All valves in spa may be under pressure and should not be opened while spa is operating. To prevent damage to spa and to avoid injury spa must be powered off completely.

**2. Glued valve?**

- a. On a new install it is possible that the valve may have been glued and then allowed to sit upside down allowing the glue to flow into the valve causing it to stick fast.
- b. If valve is glued and the glue cannot be removed valve must be replaced.

**3. Calcium levels.**

- a. If the calcium levels within the spa get too high scaling may occur within sections of the spa. The internal of the valve has very little room to function. If scaling occurs within the valve it may no longer rotate.
- b. Turn off spa
- c. Remove valve internal from the valve housing.
- d. Clean internal and valve housing using a spa safe decalcifier or rubbing alcohol.
- e. Water in spa may need to be changed or treated.

**4. Obstruction within valve.**

- a. If anything were able to get past the filter or suctions within the spa it could possibly end up inside of a valve.
- b. Turn off spa.
- c. Remove the handle and internals of the valve and inspect for any obstructions.
- d. Return valve parts to spa.

**5. Sediment within water.**

- a. Sediments from sand, dirt, and some of the chemicals used within the spa can settle in different areas such as the valves.
- b. When enough builds up it will affect the ability for the valve to rotate.
- c. Turn off spa.
- d. Remove the handle and internals of the valve and inspect for any build ups of sediments on the valve internals.
- e. If found, clean internals and drain/refill spa.

### Noise issues

**1. Determine type of sound.**

- a. Grinding – is a good indication that the bearings are failing.
  - i. If bearings are failing pump will need to be rebuilt or replaced.
- b. Vibrating – typically a loose connection, pump or grounding wire on pump.
  - i. Inspect for loose connection and tighten.
- c. Rattling – can be debris in the pump or other plumbing that is bouncing around.
  - i. Inspect location of sound by removing unions and removing any debris found.
- d. Buzzing – usually occurs when the pump is seized or receiving improper power.
  - i. Inspect voltage the pump is receiving.
  - ii. If voltage is correct, replace pump.
- e. Surging – occurs when air is entering the pump through the filter.
  - i. Make sure water level in spa is high enough.
  - ii. Verify that the zip tie on the weir has been removed.
- f. Clicking – occurs within the spa pack. This would be the relays activating.

**2. Determine location of sound.**

- a. The most common location of sound would be from the pumps as they contain the only constantly moving parts.
- b. Electrical packs can also make sounds other than the clicking of the relays but these are less likely.

## Troubleshooting Operations

### Leaks

#### 1. **Visible leak.**

- a. First determine if leak is visible.
- b. Visible leaks are the easiest to repair as they are usually accessible and properly diagnosed.

#### 2. **Non-visible leak.**

- a. Water must first collect in the base of the spa prior to being able to run outside of the spa.
- b. General area should be able to be determined by where the water is pooling within the cabinet of the spa.
- c. Once general area has been determined start from the top and work your way down inspecting for any signs of chemical residue or moisture.

#### 3. **Simple leaks.**

- a. Pump or pack unions.
  - i. Verify union is snug.
  - ii. Verify union gasket is in good shape.
  - iii. Verify the union is not cross-threaded.
- b. Jets and other wall fittings
  - i. Make sure nut on wall fitting/jet is snug allowing the gasket to seal.
  - ii. If tightening fails to resolve issue, inspect gasket.
  - iii. If gasket is in good shape inspect the hole for the wall fitting
- c. Drain hose valve
  - i. Inspect drain hose valve to ensure it is properly attached and the gaskets are not failing
- d. Overfilling spa
  - i. Make sure to properly fill the spa without overfilling.

#### 4. **Questionable leaks.**

- a. Water on the outside of the spa but none within the cabinet could be condensation or a water feature left on
  - i. Ensure cover is sealing to the best of its abilities.
  - ii. Sometimes rotating the cover may allow it to seal better.
  - iii. Make sure air valves are being closed when not in use.
  - iv. Make sure all water features such as waterfalls, water shooters, and neck jets are turned off when not in use.
- b. If the water level dropping is the only sign of a leak and the spa is only losing about 1-2 inches per week, this is most likely due to evaporation. This is normal.
  - i. Larger amounts than this without heavy use usually indicate a leak.
- c. If water is found around the spa or even within the cabinet of the spa but the water level is not dropping at all, it may be possible water is settling around the spa or within the cabinet from being overfilled or from rain.
  - i. monitor the issue.

### Light issues

#### 1. **Determine extent of issue.**

- a. Determine if the issue involves a single light, random lights, a section of lights or all the lights within the spa.

#### 2. One light failing to operate or multiple random lights not in the same area.

- a. Most likely light has fallen out of its holster (usually during shipping).
- b. Inspect inside of cabinet to ensure light is in its holster.
- c. If light is in holster and one individual led is failing to operate on a strand, replace strand.
- d. Note: if one led light is showing a different color as compared to every other light in the spa, replace strand the light is attached to.

### Light issues cont.

#### 3. Section of lights failing to operate.

- a. If an entire section of lights is failing to operate first inspect that the light strand/s is properly connected to the daisy chain.
- b. If lights are properly connected but no light is being emitted, replace light strand

#### 4. No lights working on spa.

- a. If no lights operate on the spa but the topside control led for the light button is illuminating when pressed the topside is functioning properly
- b. In the spa pack there is a 3 amp fuse for the lights
- c. Turn power off to spa, remove fuse, and test it for continuity
- d. If fuse is good, test voltage coming from the light port on the circuit board. Should be 12v
- e. The spa can have a light control box or a master light
- f. If using a master light.
  - i. Unplug daisy chain from the master light.
  - ii. If master light turns on, there is a short on the daisy chain created by a light strand clip not being properly installed.
  - iii. Plug in daisy chain.
  - iv. Unplug one light strand at a time until all the other lights turn on. This means the short has been removed.
  - v. Plug other light strands back in until all lights function properly.
- g. If using a light control box.
  - i. Unplug daisy chain from the control box.
  - ii. Test voltage coming out of light control box. Voltage should be 5v.
  - iii. If the voltage is correct, there is a short on the daisy chain created by a light strand clip not being properly installed.
  - iv. Plug in daisy chain.
  - v. Unplug one light strand at a time until all the other lights turn on. This means the short has been removed.
  - vi. Plug other light strands back in until all lights function properly.



**Master Light**



**Light Control Box**

## Troubleshooting Operations

### Bluetooth stereo

#### 1. Determine type of issue

- a. No connectivity
- b. Bad connectivity
- c. No sound
- d. Bad sound

#### 2. No connectivity

- a. If the Bluetooth is not broadcasting a signal
  - i. Check for a tone when button or switch is pressed.
  - ii. If no tone check air hose connection to air switch/button. (if equipped)
  - iii. Check wire connection from switch to sub-woofer/power supply.
  - iv. Verify Bluetooth loop wire is installed on sub-woofer.
  - v. Inspect power coming from spa pack. If no/incorrect power replace pack.
  - vi. Inspect power coming out of power supply. If no/incorrect power replace power supply.
  - vii. Inspect power coming from the switch into sub-woofer. If no/incorrect power replace switch.
  - i. If power is going into sub-woofer but it is failing to operate, replace sub-woofer.
- b. If Bluetooth is broadcasting a signal but fails to connect
  - i. Try moving the Bluetooth device closer to the spa.
  - ii. Try using a different Bluetooth device.
  - iii. If within close proximity to the sub-woofer with the side panel removed and using multiple devices and none will connect to the sub-woofer, replace sub-woofer.

#### 3. Bad connectivity

- a. If able to connect to the sub-woofer but connection fails
  - i. Try connecting and leaving the Bluetooth device in the same location without being moved.
  - ii. Try moving the Bluetooth device closer to the spa.
  - iii. Try using a different Bluetooth device.
  - iv. If connection continues to fail on multiple devices regardless of distance to Bluetooth subwoofer, replace sub-woofer.
  - v. If sub-woofer is replaced but issue persists, customer may have interference local to their location.

#### 4. No sound

- a. If able to connect to subwoofer but there is no sound coming from speakers
  - i. Make sure volume is turned on, on Bluetooth device.
  - ii. Inspect wire connections to the speakers and subwoofer.
  - iii. Inspect subwoofer volume control
  - iv. If subwoofer volume control is turned up and subwoofer puts out volume but speakers do not, replace speakers.
  - v. If subwoofer volume control is turned up and subwoofer does not put out any sound, replace subwoofer.

#### 4. Bad sound

- a. If able to connect to sub-woofer and sound is coming from the speakers and sub-woofer but the sound contains static or other sound quality issues
  - i. Inspect wire connections to the speakers and sub-woofer.
  - ii. If connections are secure, replace speakers that present the sound quality issue.

## Control Pack Codes

Code	Description	Action required
-- ---		No action required.
888		If issue persists contact customer service.
9F 1	Error code indicating that the spa could not trip the GFCI breaker. Continued use of the spa may be hazardous.	Remove power from the spa, contact electrician.
CFE	Error code indicating there is a configuration error within either the programming of the spa pack or the dip switches are not set properly. Spa will not start.	Contact dealer, service technician, or customer service.
CrC	Error code indicating that the firmware of the spa pack was not installed properly.	Contact dealer, service technician, or customer service.
dr	Error code indicating there is an inadequate amount of water, a flow issue, or air bubbles within the heater tube. Spa is shut down for 15 minutes.	If water level is normal, prime all pumps, press any button to reset, will automatically reset in 15 minutes.
drn	Code indicating the pump is operating during standby mode to assist in draining the spa.	Press jets 1 to turn off pump after water has been drained.
dy dry	Error code indicating there is an inadequate amount of water, a flow issue, or air bubbles within the heater tube. This is displayed on the third occurrence of "dr". Spa is shut down until manually reset. To reset, press any button.	Refer to the flow issue section of the troubleshooting guide.
Ec Ecn	Indicates the spa is in economy mode.	Refer to the topside control section of manual to change modes.
F 1	Indicates the spa is set to filter 1 out of every 12 hours	Change setting to F2, F3, or F4
F2 FILL2	Indicates the spa is set to filter 2 out of every 12 hours	This is the recommended setting, no action required.
F3	Indicates the spa is set to filter 3 out of every 12 hours	No action required.
F4 FILL4	Indicates the spa is set to filter 4 out of every 12 hours	No action required.
F5	Indicates the spa is set to filter 5 out of every 12 hours	Change setting to F2, F3, or F4
F6 FILL6	Indicates the spa is set to filter 6 out of every 12 hours	Change setting to F2, F3, or F4
F7	Indicates the spa is set to filter 7 out of every 12 hours	Change setting to F2, F3, or F4
F8 FILL8	Indicates the spa is set to filter 8 out of every 12 hours	Change setting to F2, F3, or F4
F9	Indicates the spa is set to filter 9 out of every 12 hours	Change setting to F2, F3, or F4
F 10	Indicates the spa is set to filter 10 out of every 12 hours	Change setting to F2, F3, or F4
F 11	Indicates the spa is set to filter 11 out of every 12 hours	Change setting to F2, F3, or F4
FC F 12 FILLC	Indicates the spa is set to filter 12 out of every 12 hours or filter constantly.	Change setting to F2, F3, or F4. After changing setting, spa power must be turned off and then back on for the setting to take effect.

## Control Pack Codes

Code	Description	Action required
HH OHX	Error code indicating one of the temperature sensors has detected a temperature of 118 degrees Fahrenheit. After temperature lowers spa will reset.	<b>DO NOT ENTER WATER!!</b> Remove cover and allow spa to cool. If water is not hot, refer to the flow issue section of the troubleshooting guide.
HL HFL	Error code indicating there is a substantial difference between the temperature sensors. This could indicate an inadequate amount of water, a flow issue, or air bubbles within the heater tube.	If water level is normal, prime all pumps, press any button to reset.
HOT	Error code indicating that a pump appears to have been stuck on the last time the spa was under power.	<b>DO NOT ENTER WATER!!</b> Remove cover and allow spa to cool. If issue persists contact dealer, service technician, or customer service.
IC ICE	Error code indicating the spa has detected potential freezing conditions. Spa heater is shut down, but pumps will run continuously until temperature of spa water increases above 45 degrees Fahrenheit.	<b>DO NOT ENTER WATER!!</b> Allow water to heat up or add warm water to the spa until heater engage and code goes away. do not overfill spa.
LF	Error code indicating a persistent low flow issue. Message appears on 5th occurrence of "hl" or "hfl". Heater is shut down.	Refer to the flow issue section of the troubleshooting guide. To reset, press any button.
OH OHS	Error code indicating one of the temperature sensors has detected a temperature of 110 degrees Fahrenheit. After temperature lowers spa will reset.	Remove cover and allow spa to cool. If water is not hot, refer to the flow issue section of the troubleshooting guide.
PHH	Error code indicating the pH of the spa is too high.	Test/adjust pH balance
PHL	Error code indicating the pH of the spa is too low.	Test/adjust pH balance
Pr	Indicates the spa is running its prime cycle. This will last for about 3-5 minutes after the spa is powered up.	No action required.
PST	Error code indicating a hardware failure.	Contact dealer, service technician, or customer service.
rCR	Reminder code to install new mineral cartridge (as needed)	Install new mineral cartridge (if needed)
rCH	Reminder code to remove and install new filter (every 365 days)	Install new filter
rCL	Reminder code to clean and reinstall filter (every 30 days)	Clean and reinstall filter
rCO	Reminder code to clean and condition spa cover (every 30 days)	Clean and condition spa cover
rdr	Reminder code to drain and refill spa (every 90 days)	Drain and refill spa
rPH	Reminder code to test and adjust pH levels (every 7 days)	Test/adjust pH balance
rSA	Reminder code to test and adjust sanitizer levels (every 7 days)	Test/adjust sanitizer levels
rTG	Reminder code to test and reset GFCI (every 30 days)	Test and reset GFCI
rtr	Reminder code to clean and condition wood (every 180 days)	Clean and condition wood
rTC	Error code indicating a hardware failure.	Contact dealer, service technician, or customer service.
SA Sna	Error code indicating that sensor A is experiencing an issue. Spa is shut down. May appear temporarily in an overheat situation and disappear once heater cools.	Refer to the spa failing to heat section of the troubleshooting guide.
Sb Snb	Error code indicating that sensor B is experiencing an issue. Spa is shut down. May appear temporarily in an overheat situation and disappear once heater cools.	Refer to the spa failing to heat section of the troubleshooting guide.



## Control Pack Codes

Code	Description	Action required
S <sub>n</sub> S <sub>n</sub> S	Error code indicating the temperature sensors are out of balance. If code is flashing intermittently with the temperature of the spa it may be a temporary issue. If the code is displayed solid and by itself, the spa is shut down.	Refer to the spa failing to heat section of the troubleshooting guide.
S <sub>AH</sub>	Error code indicating the sanitizer of the spa is too high.	Test/adjust sanitizer levels
S <sub>AL</sub>	Error code indicating the sanitizer of the spa is too low.	Test/adjust sanitizer levels
S <sub>b</sub> y	Indicates standby mode has been activated.	Press any button other than jets 1 to resume normal operation.
S <sub>E</sub>	Indicates the spa is in "standard in economy mode". During this time the spa acts as if it is in standard mode. After one hour the spa will revert to economy mode.	After one hour the spa will revert to economy mode.
S <sub>L</sub> S <sub>LP</sub>	Indicates the spa is in sleep mode.	Refer to the topside control section of manual to change modes.
S <sub>t</sub> S <sub>td</sub>	Indicates the spa is in standard mode.	Refer to the topside control section of manual to change modes.
S <sub>t</sub> U	Error code indicating that there appears to be a pump that is stuck on. This may cause the temperature of the spa to rise to unsafe conditions.	<b>DO NOT ENTER WATER!!</b> Remove cover and allow spa to cool. If issue persists contact dealer, service technician, or customer service.



## Register Your Product

# Product Registration

**Register your spa online!**

**Go to [strongspas.com](http://strongspas.com) and click on Register.**

It is important that you register your product as soon as possible.

**IMPORTANT:**

**Warranty is void if the spa is moved to any location that is not the original 'Ship To' address.**

**Locating the product serial number**

The serial number of your spa is located on a metal plate attached to exterior of the spa.

You will need this number to properly register your spa and activate coverage.

Write this information in the space provided below.

**Please have the following information ready when registering your spa.**

Customer name: \_\_\_\_\_

Customer phone number: \_\_\_\_\_

Customer email: \_\_\_\_\_

Physical Delivery address: \_\_\_\_\_

Spa Serial Number: \_\_\_\_\_

Date Delivered: \_\_\_\_\_

Dealer/Vendor Name: \_\_\_\_\_

Copy of receipt: \_\_\_\_\_

**KEEP THIS PAGE FOR YOUR RECORDS!**

For customer service, please call  
**1-800-787-6649**

**READ AND FOLLOW ALL INSTRUCTIONS**

*To reduce the risk of injury, do not permit children to use this product unless they are closely supervised at all times.*

**SAVE THESE INSTRUCTIONS**