

DOREL ASIA

PARSONS CHAIR

Model No:

WM3738-DF

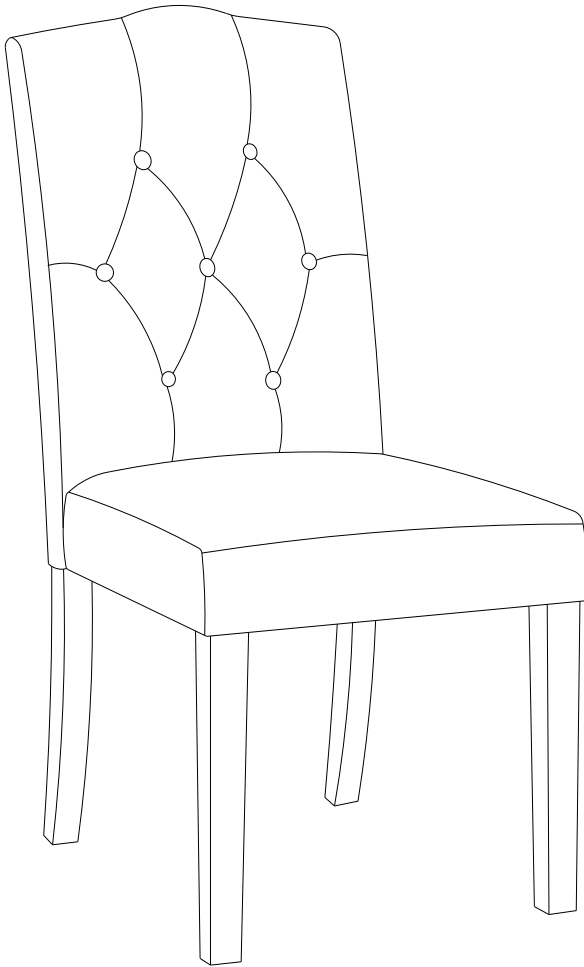

UPC CODE:

0-65857-16528-9

NOTE:

THIS INSTRUCTION BOOKLET
CONTAINS **IMPORTANT** SAFETY
INFORMATION. PLEASE READ AND
KEEP FOR FUTURE REFERENCE.

Lot number:

(TAKEN FROM CARTON)

Date of purchase:

____ / ____ / ____

DO NOT RETURN PRODUCT TO THE STORE.

If a part is missing or damaged, contact our customer service department. We will replace the part **FREE** of charge.



Tel #: 1-800-295-1980

E-Mail: das@dorel.com

Fax #: 514-353-7819

CUSTOMER SERVICE

If you are missing parts or have any questions about this product, contact our customer service representative first!

 **CALL 1-800-295-1980**

You can also order parts by writing to the address listed below. Please include the product model number, color and a detailed description of the part.

**Customer Service Department No. 413
12345 Albert-Hudon Boulevard, Suite 100
Montreal, Quebec
Canada H1G 3L1**

E-MAIL: das@dorel.com

NOTES

- * Ensure all parts and components are present before beginning assembly.
- * Assemble on a soft, smooth surface to prevent damage to product finish.
- * **DO NOT** use power tools.
- * **CAUTION:** Adult assembly required.
- * Assembly and handling will require two people.
- * Estimated assembly time: 15 minutes.

CARE AND CLEANING

Dust regularly with a clean, dry cloth to avoid soil build-up. Wipe away spills immediately to prevent staining. Use a cloth dampened with water or professional product to clean the fabric. Always test an inconspicuous area first. Allow upholstery to dry and brush lightly. Keep away from heat to avoid glazing, melting or scorching.

MAINTENANCE

Check bolts/screws periodically and tighten them if necessary.

LIMITED WARRANTY

Dorel Asia warrants its product to be free from defects in material and workmanship and agrees to remedy any such defect. This warranty covers 1 year from the date of original purchase. This warranty is valid only upon presentation of proof of purchase. This is solely limited to the repair or replacement of defective furniture components and no assembly labor is included. This warranty does not apply to any product which has been improperly assembled, subjected to misuse or abuse or which has been altered or repaired in any way. Any wearing, tearing, fading or splitting of the fabric is not covered under the warranty. This warranty gives you specific legal rights and you may also have other rights which vary from State to State.







WARNING: Should this product become damaged, and/or components are broken or missing, DO NOT USE.

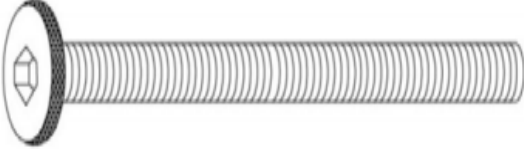

PARSONS CHAIR

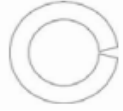
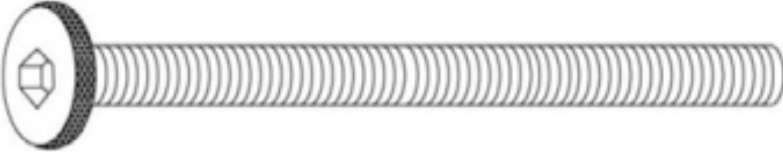
WM3738-DF

HARDWARE LIST

| | | |
|--|--|---|
| <div style="border: 1px solid black; padding: 2px; width: 30px; margin: 0 auto;">1</div>  <p style="text-align: center;">Ø5/16" X 60mm</p> | <div style="border: 1px solid black; padding: 2px; width: 30px; margin: 0 auto;">2</div>  <p style="text-align: center;">Ø22 X 1.8mm</p> | <div style="border: 1px solid black; padding: 2px; width: 30px; margin: 0 auto;">3</div>  <p style="text-align: center;">Ø12.5 X 1.2mm</p> |
| <p>HEX SOCKET HEAD BOLT</p> <p>6 PCS</p> | <p>FLAT WASHER</p> <p>10 PCS</p> | <p>SPRING WASHER</p> <p>10 PCS</p> |
| <div style="border: 1px solid black; padding: 2px; width: 30px; margin: 0 auto;">4</div>  <p style="text-align: center;">Ø5/16" X 90mm</p> | <div style="border: 1px solid black; padding: 2px; width: 30px; margin: 0 auto;">5</div>  | |
| <p>HEX SOCKET HEAD BOLT</p> <p>4 PCS</p> | <p>ALLEN KEY</p> <p>1 PC</p> | |

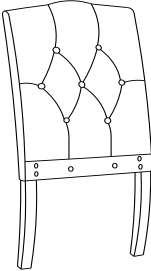
PARTS LIST

| | | |
|--|---|--|
| <div style="border: 1px solid black; padding: 2px; width: 30px; margin: 0 auto;">A</div>  | <div style="border: 1px solid black; padding: 2px; width: 30px; margin: 0 auto;">B</div>  | <div style="border: 1px solid black; padding: 2px; width: 30px; margin: 0 auto;">C</div>  |
| <p>BACK FRAME</p> <p>1 PC</p> | <p>SEAT FRAME</p> <p>1 PC</p> | <p>FRONT LEG</p> <p>2 PCS</p> |

PARSONS CHAIR

WM3738-DF

STEP 1:

Place back frame (A) on a clean, smooth surface.

Remove the fabric lining underneath seat frame (B).

Attach the seat frame (B) to back frame (A) with flat washers (2), spring washers (3) and hex socket head bolts (1) through the center of the seat frame (B).

Use Allen key (5) to tighten the bolts.

NOTE: Do not fully tighten bolts.

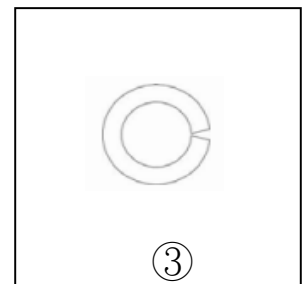
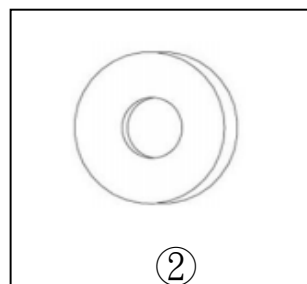
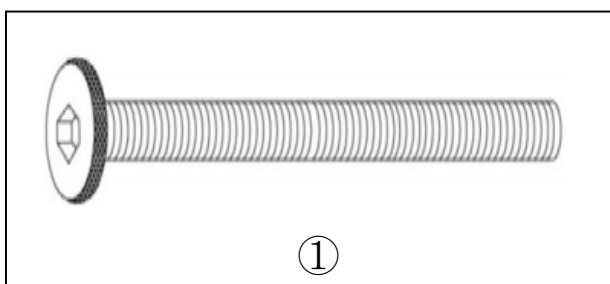
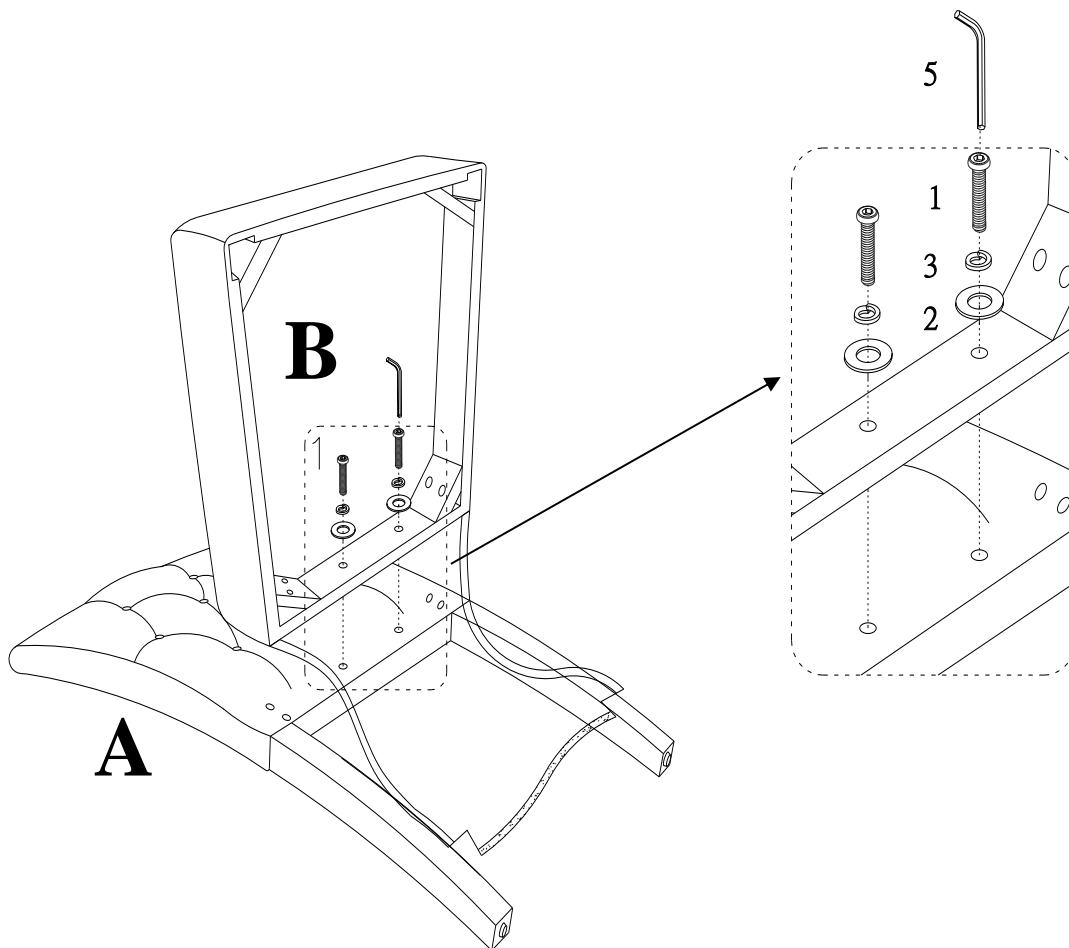

PARSONS CHAIR

WM3738-DF

STEP 2:

Secure seat frame (B) to back frame (A) with flat washers (2), spring washers (3) and hex socket head bolts (4).

Use Allen Key (5) to tighten the bolts.

NOTE: Do not fully tighten bolts.

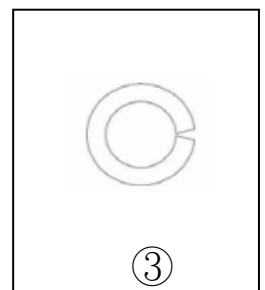
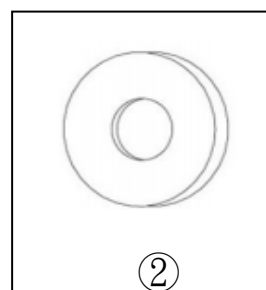
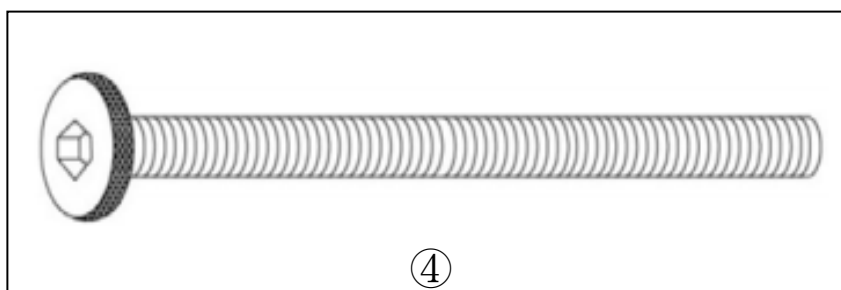
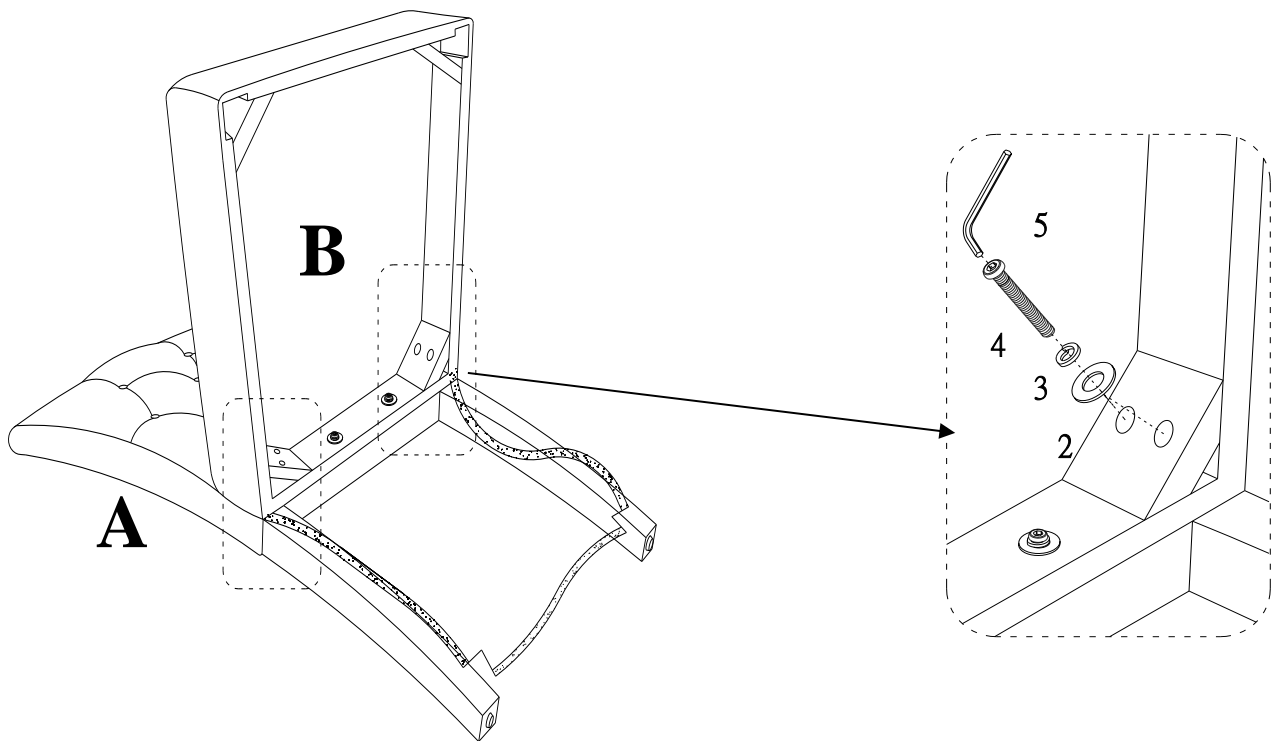

PARSONS CHAIR

WM3738-DF

STEP 3:

Attach front legs (C) to seat frame (B) with flat washers (2), spring washers (3) and hex socket head bolts (1). Use Allen key (5) to tighten the bolts. Tighten all bolts previously installed. Place the fabric lining back into place.

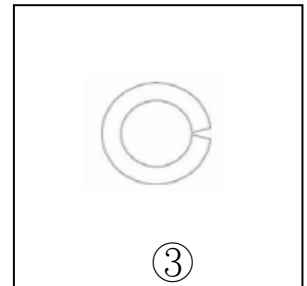
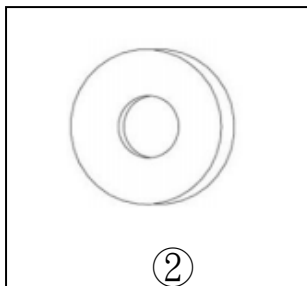
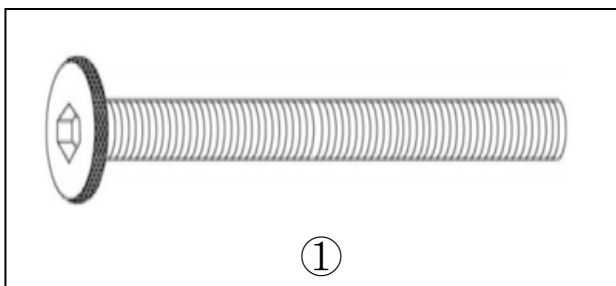
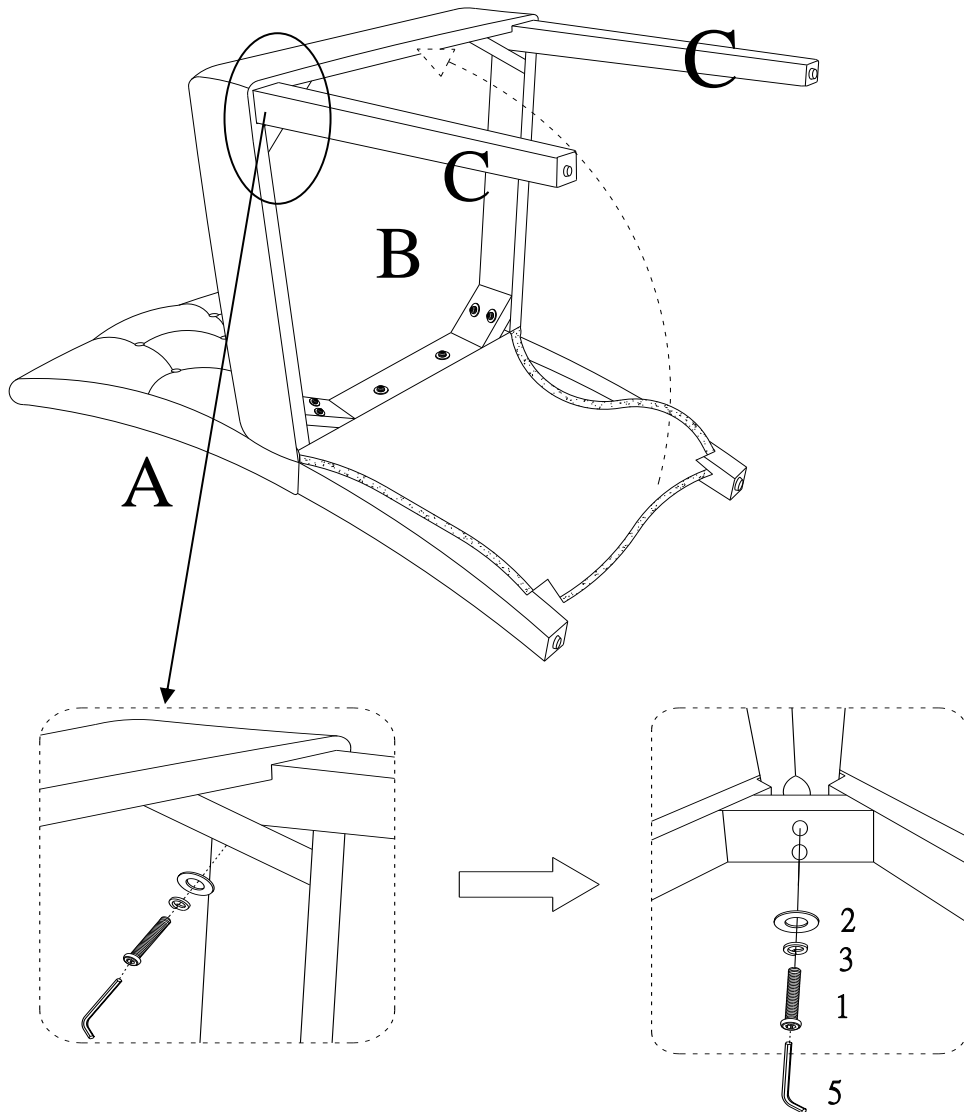

PARSONS CHAIR

WM3738-DF

STEP 4:

Turn the chair upright.

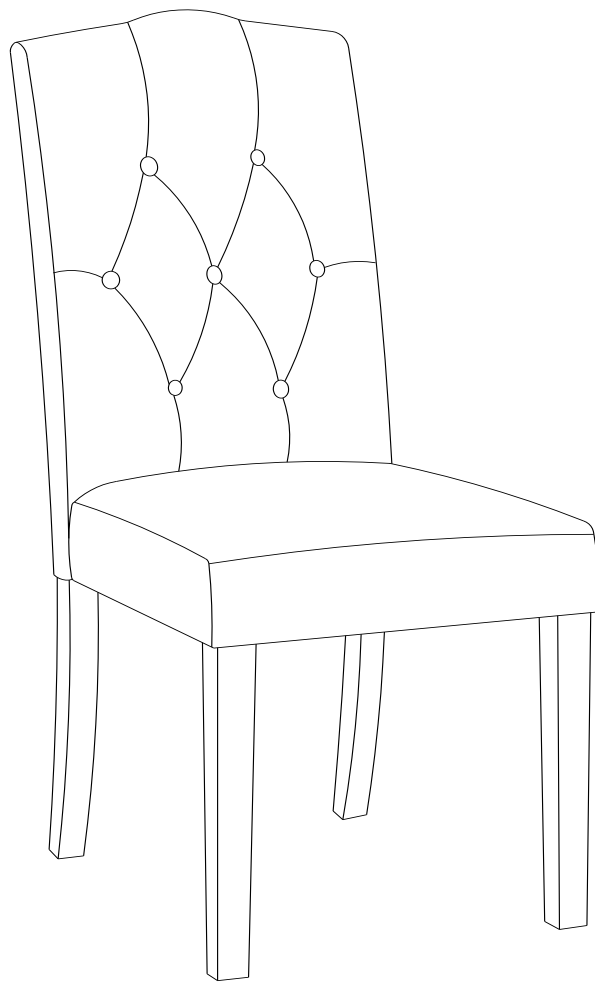

Note: Legs are equipped with adjustable levelers. Before placing this item in the desired location, make sure that the chair rests evenly on the floor by turning the adjustable levelers clockwise or counterclockwise (as needed).

PARSONS DINING CHAIRS

WM3738-DF



CAUTION: This unit is intended for use only with the products and/or maximum weights indicated. Use with other products and/or products heavier than the maximum weights indicated may result in instability or cause possible injury.

Dust regularly with a soft, dry cloth to prevent soil build-up. Wipe away spills immediately to prevent staining. Use a cloth dampened with water or a professional product to clean the fabric. Always test an inconspicuous area first. Allow upholstery to dry and brush lightly. Keep away from heat to avoid glazing, melting or scorching.

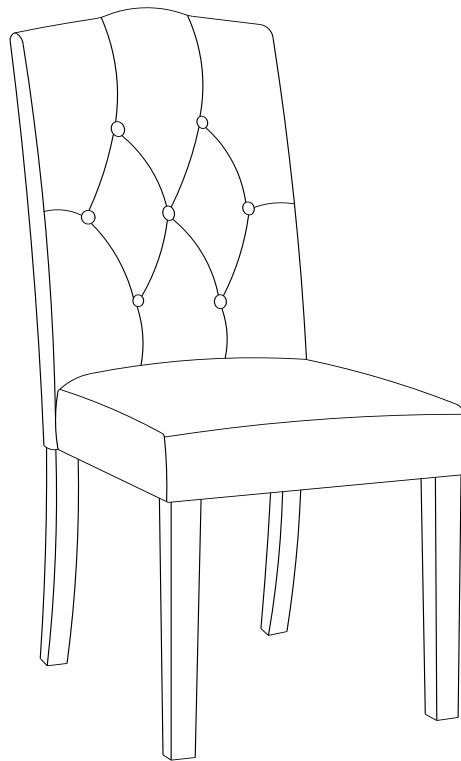

That's it ! You've finished assembling your chairs.

DO NOT RETURN PRODUCT TO THE STORE.

If a part is missing or damaged, contact our customer service department. We will replace the part **FREE** of charge.



Tel #: 1-800-295-1980
E-Mail: das@dorel.com
Fax #: 514-353-7819

Customer Service

PLEASE DO NOT RETURN THIS PRODUCT TO THE STORE

PLEASE CONTACT CUSTOMER SERVICE REPRESENTATIVES AT THE FOLLOWING NUMBERS SHOULD THERE BE ANY MISSING OR DEFECTIVE PART(S).

| | |
|--|---|
| Customer Service Phone Number 1-800-295-1980 | Email: das@dorel.com |
| Customer Service Fax Number 514-353-7819 | |

Request Date:

Name:

Shipping Address:

Street & Number:

City & State:

Zip Code:

Day Time Phone Number:

(including area code)

Date & Place of Purchase:

Part(s) description and quantity (Please be sure to list model number or SKN number):

Customer Service Representative Mailing Address:

Customer Service Department No. 413, 12345 Albert-Hudon Boulevard, Suite 100, Montreal, QC, Canada, H1G 3L