

**#90363E**

**110-120V~60Hz, 12A at 68°F (20°C)**



**SaluSpa™**

**Owner's Manual**

Website: [www.bestwaycorp.com](http://www.bestwaycorp.com)

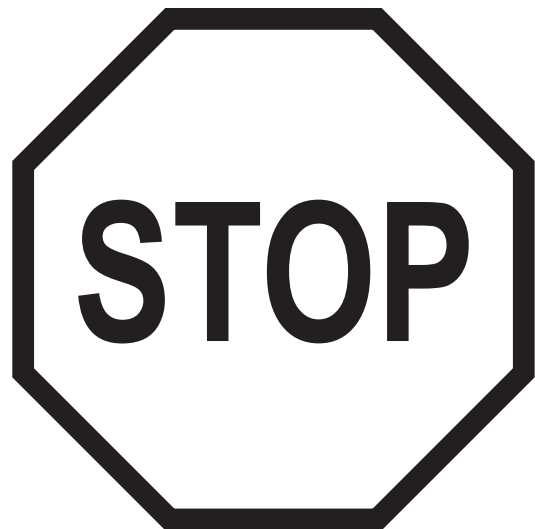

**DO NOT RETURN THIS ITEM TO THE STORE  
OR WEBSITE WHERE IT WAS PURCHASED.  
CONTACT US DIRECTLY WITH ANY QUESTIONS,  
OR FOR DEFECTIVE OR WARRANTY CLAIMS.  
CALL US DIRECTLY FOR IMMEDIATE HELP!**

Toll-Free: 1-855-838-3888

# CONTENTS

<b>1. Warning</b> ..... P2	<b>5. Maintenance</b> ..... P8
<b>2. Specifications</b> ..... P5	Filter Cartridge Maintenance
<b>3. Installation Instructions</b> .... P5	Water Maintenance
Selected Location	Air-Valve Adjustment
GFCI Test	Draining the Spa
Assembly	Cleaning the Spa
<b>4. Pump Operation</b> ..... P8	Spa Repair
Control Panel	SaluSpa Storage
Alarms	<b>6. Troubleshooting</b> ..... P11
	<b>7. Warranty</b> ..... P12

## WARNING IMPORTANT SAFETY INSTRUCTIONS

When using this electrical equipment, basic safety precautions should always be followed, including the following:

### READ AND FOLLOW ALL INSTRUCTIONS.

**WARNING** – To reduce the risk of injury, do not permit children to use this product unless they are closely supervised at all times.

A wire connector is provided on this unit to connect a minimum 8 AWG (8.37 mm<sup>2</sup>) solid copper conductor between this unit and any metal equipment, metal enclosures of electrical equipment, metal water pipe, or conduit within 5 feet (1.5 m) of the unit.

**DANGER** – Risk of injury.

- Replace damaged cord immediately.
- Do not bury cord.
- Connect to a grounded, grounding type receptacle only.

**WARNING** – This product is provided with a ground-fault circuit-interrupter integrated with the power plug at the end of the cord. The GFCI must be tested before each use. With the product operating, push the test button on the GFCI and the product should not operate. Push the reset button on the GFCI and the product should now operate normally. When the product fails to operate in this manner, there is a ground current flowing indicating the possibility of an electrical shock. Disconnect the power until the fault has been identified and corrected.

**DANGER** – Risk of Accidental Drowning. Extreme caution must be exercised to prevent unauthorized access by children. To avoid accidents, ensure that children cannot use this spa unless they are supervised at all times.

**DANGER** – Risk of Injury. The suction fittings in this spa are sized to match the specific water flow created by the pump. Should the need arise to replace the suction fittings or the pump, be sure that the flow rates are compatible. Never operate spa if the suction fittings are broken or missing. Never replace a suction fitting with one rated less than the flow rate marked on the original suction fitting.

**DANGER** – Risk of Electric Shock. Install at least 5 feet (1.5 m) from all metal surfaces. As an alternative, a spa may be installed within 5 feet of metal surfaces if each metal surface is permanently connected by a minimum 8 AWG (8.37 mm<sup>2</sup>) solid copper conductor to the wire connector on the terminal box that is provided for this purpose.

**DANGER** – Risk of Electric Shock. Do not permit any electric appliance, such as a light, telephone, radio, or television, within 5 feet (1.5 m) of a spa.

**WARNING** – To reduce the risk of injury:

- The water in a spa should never exceed 104°F (40°C). Water temperatures between 100°F (38°C) and 104°F (40°C) are considered safe for a healthy adult. Lower water temperatures are recommended for young children and when spa use exceeds 10 minutes.
- Since excessive water temperatures have a high potential for causing fetal damage during the early months of pregnancy, pregnant or possibly pregnant women should limit spa water temperatures to 100°F (38°C).
- Before entering a spa, the user should measure the water temperature with an accurate

- thermometer since the tolerance of water temperature-regulating devices varies.
- d) The use of alcohol, drugs, or medication before or during spa use may lead to unconsciousness with the possibility of drowning.
  - e) Obese persons and persons with a history of heart disease, low or high blood pressure, circulatory system problems, or diabetes should consult a physician before using a spa.
  - f) Persons using medication should consult a physician before using a spa since some medication may induce drowsiness while other medication may affect heart rate, blood pressure, and circulation.

**WARNING:** TO AVOID ELECTRIC SHOCK, DO NOT USE THE SPA WHEN IT IS RAINING.

**WARNING:** Water attracts children; Always attach a spa cover after each use.

**WARNING:** TO REDUCE THE RISK OF INJURY: Never add water that is higher than 104°F (40°C) into the Spa.

**CONSULT YOUR PHYSICIAN FOR RECOMMENDATIONS.**

**CAUTION:** The spa should not be setup or left out in temperatures lower than 40°F (4°C).

**CAUTION:** Do not use the spa alone.

**CAUTION:** Always enter and exit the spa slowly and cautiously. Wet surfaces are slippery.

**CAUTION:** To avoid damage to the pump, the spa must never be operated unless the spa is filled with water.

**CAUTION:** Immediately leave spa if the user feels uncomfortable or sleepy.

**NOTE:** Please examine equipment before use. Notify Bestway® at the customer service address listed on this manual for any damaged or missing parts at the time of purchase. Verify that the equipment components represent the model that you had intended to purchase.

**NOTE:** This equipment has been tested and found to comply with the limits for a Class B digital device, pursuant to part 15 of the FCC Rules. These limits are designed to provide reasonable protection against harmful interference in a residential installation. This equipment generates, uses and can radiate radio frequency energy and, if not installed and used in accordance with the instructions, may cause harmful interference to radio communications. However, there is no guarantee that interference will not occur in a particular installation. If this equipment does cause harmful interference to radio or television reception, which can be determined by turning the equipment off and on, the user is encouraged to try to correct the interference by one or more of the following measures:

- Reorient or relocate the receiving antenna.
- Increase the separation between the equipment and receiver.
- Connect the equipment into an outlet on a circuit different from that to which the receiver is connected.
- Consult the dealer or an experienced radio/TV technician for help.

## SAVE THESE INSTRUCTIONS

### ASSEMBLY: THE PROVIDED WARNING LABEL

# WARNING

## REDUCE THE RISK OF ELECTROCUTION

1. NEVER PLACE AN ELECTRIC APPLIANCE WITHIN 5 FEET OF SPA.

## REDUCE THE RISK OF CHILD DROWNING

1. SUPERVISE CHILDREN AT ALL TIMES.
2. ATTACH SPA COVER AFTER EACH USE.

## REDUCE THE RISK OF OVERHEATING

1. CHECK WITH A DOCTOR BEFORE USE IF PREGNANT, DIABETIC, IN POOR HEALTH, OR UNDER MEDICAL CARE.
2. EXIT IMMEDIATELY IF UNCOMFORTABLE, DIZZY, OR SLEEPY. SPA HEAT CAN CAUSE HYPERTHERMIA AND UNCONSCIOUSNESS.
3. SPA HEAT IN CONJUNCTION WITH ALCOHOL, DRUGS, OR MEDICATION CAN CAUSE UNCONSCIOUSNESS.

**WHEN PREGNANT,** SOAKING IN HOT WATER FOR LONG PERIODS CAN HARM YOUR FETUS. MEASURE WATER TEMPERATURE BEFORE ENTERING.

1. DO NOT ENTER SPA IF WATER IS HOTTER THAN 100°F (38°C)
2. DO NOT STAY IN SPA FOR LONGER THAN 10 MINUTES.

**NOTE: The warning label must be posted near your spa in a readable position during using your spa.**

1. Take out the warning label from the accessory kit.
2. Carefully peel the warning label.
3. Affix the warning label.

To order the warning label, please contact your local Coleman After Sales Service.

## IMPORTANT !

To reach 104°F (40°C), the heating duration required is base on the starting water temperature and ambient temperature, the data below is purely for reference. To display the current water temperature, run the filter system for at least a minute.

Ambient Temperature	Water Temperature	Set Temperature	Heating Duration
50°F (10°C)	50°F (10°C)	104°F (40°C)	32 h
59°F (15°C)	59°F (15°C)	104°F (40°C)	26 h
68°F (20°C)	68°F (20°C)	104°F (40°C)	20 h
77°F (25°C)	77°F (25°C)	104°F (40°C)	14 h
86°F (30°C)	86°F (30°C)	104°F (40°C)	9 h

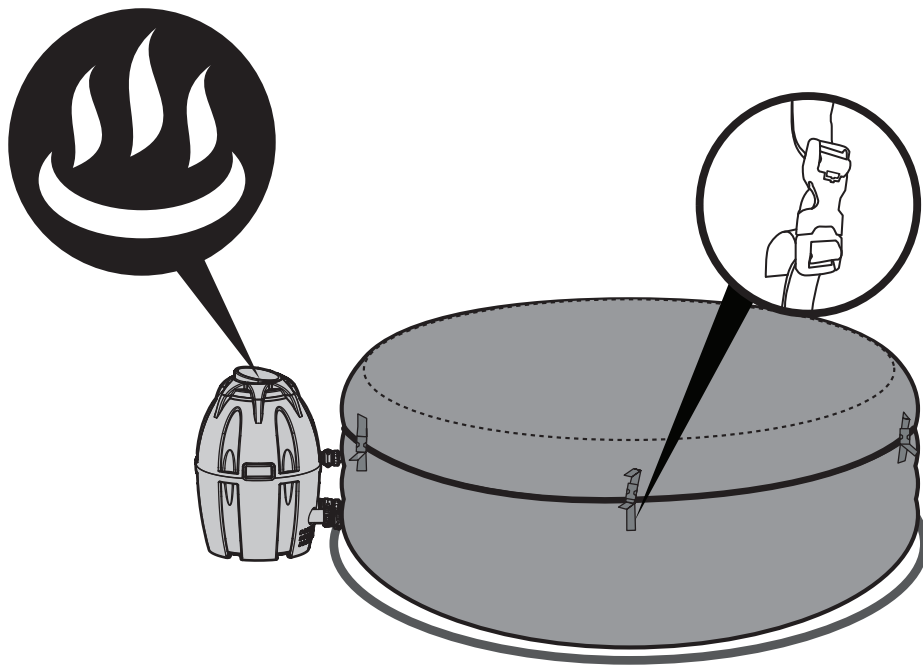

**Be sure to cover the spa with the spa cover whenever the heating function is activated. Leaving the spa uncovered will increase the heating duration required.**

**Please do not use the spa when ambient temperature is lower than 39°F (4°C).**

# SPECIFICATIONS

Capacity:	4-6 Adults	Massaging Turbo Blower:	6.5A	Increased Heat Rate:	Approximately 2-3°F/h (1-1.5°C/h)
Water Capacity (80%):	242 gal. (916 L)	Heat Element:	11.3A at 68°F (20°C)	Power Rate:	110-120V AC, 12A at 68°F (20°C)
Inflated Size:	77in. x 28in. (1.96m x 71cm)	Pump:	0.7A Circulation Filter Pump	Working Pressure:	1.2PSI (0.08Bar)
Filled Weight:	2,103 lbs. (954 kg)	Temperature Capacities:	104°F (40°C)	Actual Water Flow:	320 gal./h (1,211 L/h)

**NOTE:** The above heating rate is base on a lab test conducted with an ambient temperature of 77°F (25°C) and above.

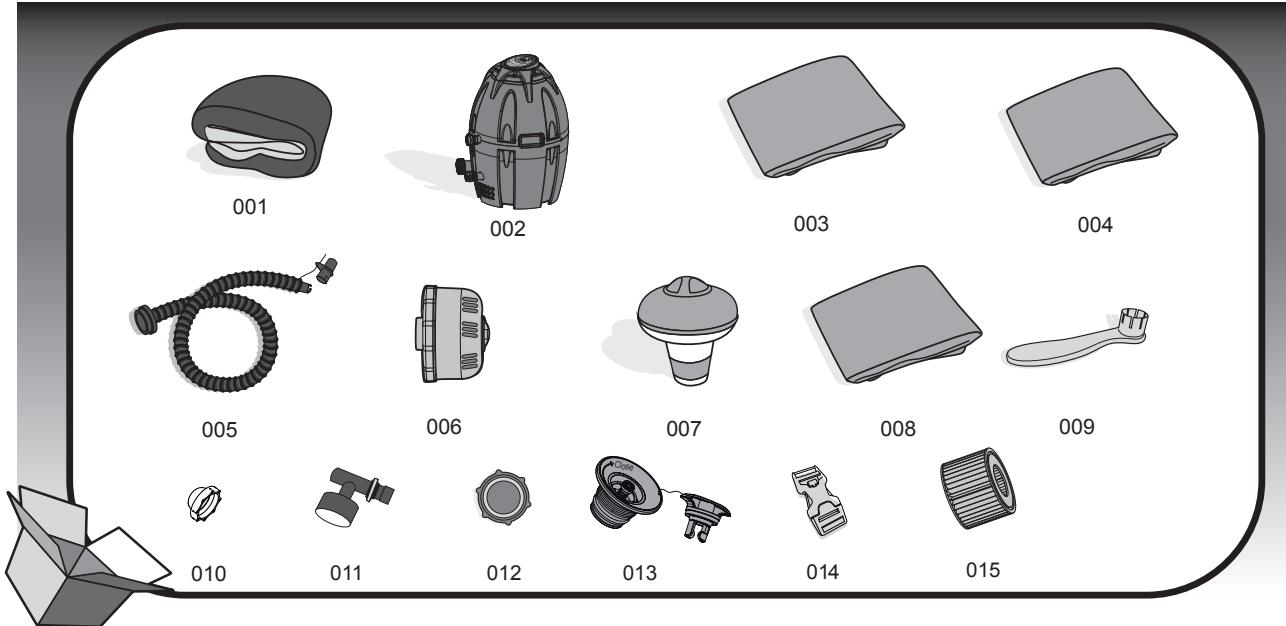

Part N.	Part Code	Description	QTY
001	90363TASS17	Pool liner	1
002	P4G080USASS17	Spa Heater	1
003	P5G400ASS17	Top Leatheroid Cover	1
004	90363GASS17	Inflatable Cover	1
005	P6930	Inflation Hose	1
006	P6653	Filter Set	2
007	58426S17-01	Chemical Floater	1
008	58321(H)S15	Ground Mat	1
009	F6H189ASS	Wrench	1
010	P6575	Stoppers	3
011	P61199	Pressure Gauge	1
012	P6611	Cover Adapter A	1
013	P6H971	Inflation Valve	1
014	F6414ASS	Buckle	6
015	90352E	Filter cartridge (VI)	2

# INSTALLATION

## Selected Location

**IMPORTANT:** Because of the combined weight of the SaluSpa, water, and users, it is extremely important that the base where the SaluSpa is installed is smooth, flat, level and capable of

uniformly supporting the weight for the entire time the SaluSpa is installed (not on the carpet or other similar material). If the SaluSpa is placed on a surface, which does not meet these requirements, any damage caused by improper support is not covered under the manufacturer's warranty. It is the responsibility of the SaluSpa owner to assure the integrity of the site at all times.

### 1. Indoor Installation:

**Be aware of special requirements if you install the spa indoors.**

- Humidity is a natural side effect with SaluSpa installation. Determine the effects of moisture on exposed wood, paper, etc. in the proposed location. To minimize these effects, it is best to provide plenty of ventilation to the selected area. An architect can help determine if more ventilation is needed.

### 2. Outdoor Installation:

- During filling, draining or when in use, water may spill out of the spa. Therefore the SaluSpa should be installed near a floor drain.
- Do not leave the spa's surface exposed to direct sunlight for long periods of time.

## GFCI Test

**IMPORTANT: RISK OF ELECTRIC SHOCK. THE GFCI MUST BE TESTED BEFORE TURNING ON THE PUMP EACH TIME.**

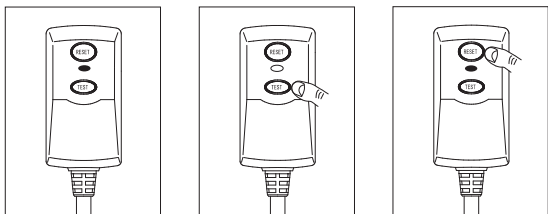

1. Plug the GFCI into a power outlet, the indicator turns red.
2. Press the test button, the indicator turns off.
3. Press the reset button, the indicator turns red and the spa is ready for use.

**WARNING:** The GFCI plug must be tested before each use to avoid risk of electric shock.

**WARNING:** Before inserting plug into a power outlet, make sure the current rate of the power outlet is suitable for the pump.

**WARNING:** Do not use the pump if this test fails and contact our Aftersales Service.

**NOTE:** When inflating, you will notice that air will be expelled from the area where the air hose connects to the pump, this is normal for technique requirements.

**NOTE:** Do not use an air compressor to inflate the pool.

**NOTE:** Do not drag the pool on rough ground as this may cause damage to the pool liner.

**NOTE:** Inflation time for reference only.

**NOTE:** Pressure gauge is for inflation purpose only, and the value of the pressure gauge is just for reference, should not be used as a precision instrument.

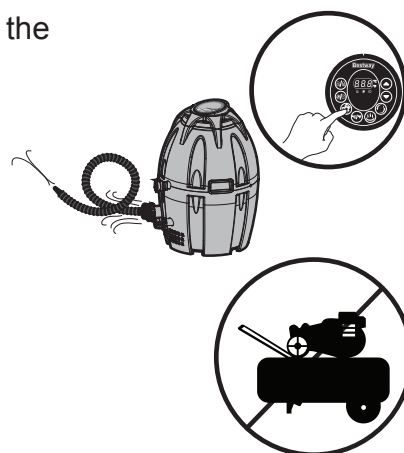

### Air Valve Check

Always check the air valve carefully before inflation to ensure there is not an air leak. If the air valve is loose, use the provided wrench to fasten the air valve following these steps:

With one hand, hold the backside of the air valve from the inner side of the spa wall and turn the wrench clockwise.

**NOTE:**

1. Do not over tighten.
2. Do not adjust the air valve connector when the spa is in use.

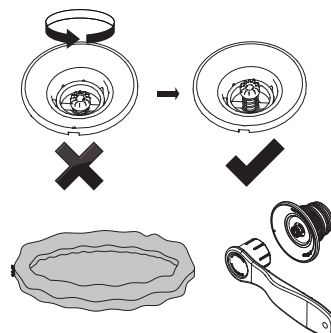

1.

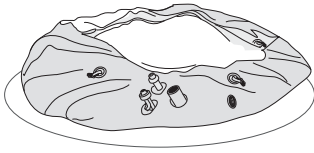

2.

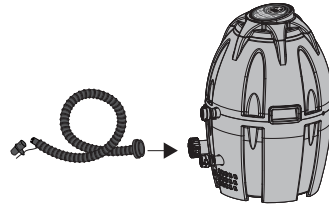

3.

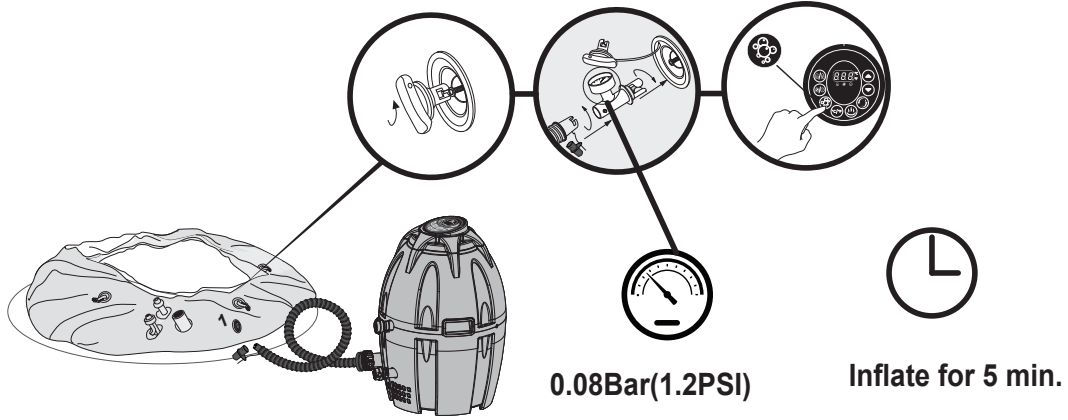

4.

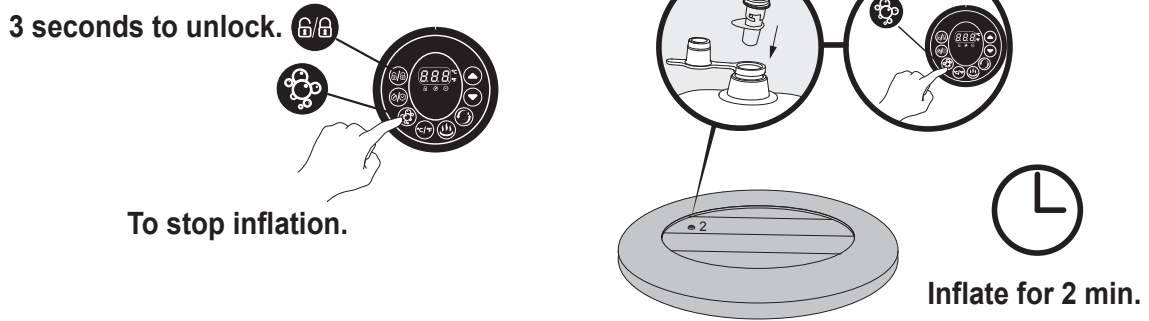

5.

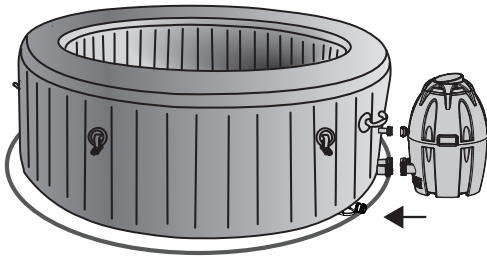

6.

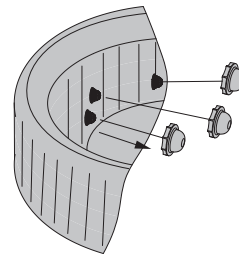

7.

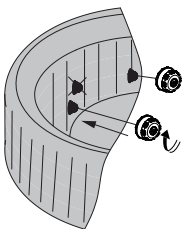

8.

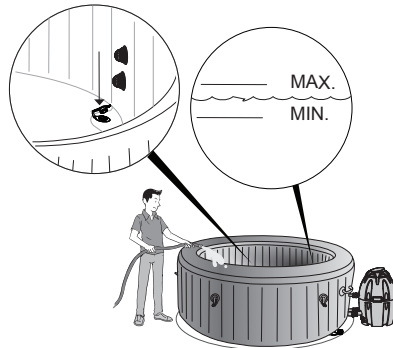

9.

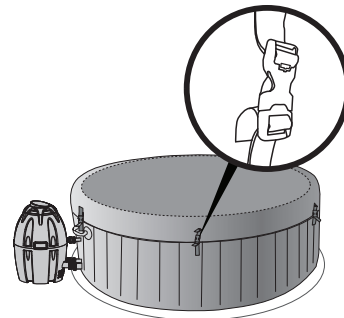

Hyperthermia occurs when the internal temperature of the body reaches a level several degrees above the normal body temperature of 98.6°F (37°C). The symptoms of hyperthermia include an increase in the internal temperature of the body, dizziness, lethargy, drowsiness, and fainting. The effects of hyperthermia include failure to perceive heat; failure to recognize the need to exit spa or hot tub; unawareness of impending hazard; fetal damage in pregnant women; physical inability to exit the spa or hot tub; and unconsciousness resulting in the danger of drowning.

**WARNING –** The use of alcohol, drugs, or medication can greatly increase the risk of fatal hyperthermia.

**WARNING: WATER TEMPERATURE IN EXCESS OF 100°F (38°C) CAN BE INJURIOUS TO YOUR HEALTH.**

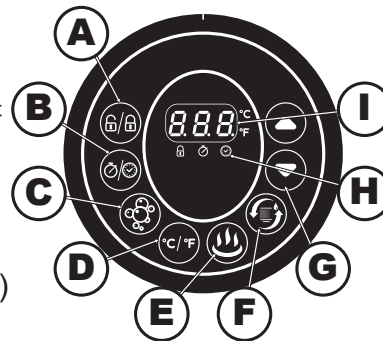

**A** Lock/Unlock Button

The pump has a 5-minute auto-lock. To lock or unlock the pump, place a finger over the lock/unlock button for 3 seconds.

**B** Power-Saving Timer Button

This is a newly added function, designed to help avoid wasting power by setting the time and duration of the heating cycle for the spa. This way, you can enjoy your spa at the time you desire, without needing to leave the heater on at all times.

**STEP 1:** Set the heating duration

1. Press the button until the LED starts to flash.
2. Press the or button to adjust the heating duration (From 1-48 hours).
3. Press the button again to confirm the heating duration.

**STEP 2:** Set the number of hours FROM NOW when the heater will activate

1. After setting the heating duration, the LED starts to flash.
2. Press the or button to adjust the hours until time of activation (From 0-99 hours).
3. Press button again or simply touch nothing for 10 seconds to confirm the setting. The LED will light steadily, and the countdown to heater activation will begin.

To modify the timer settings: Press the button and use the or button to adjust.

Cancel the setting: Press the button for 2 seconds.

**NOTE:** After setting, the screen flashes the current temperature and time alternately.  
**NOTE:** Timer adjustment (amount of time with the heater ON) may be set from 1 to 48 hours; Reservation time adjustment (the number of hours FROM NOW when the heater will begin to function) may be set from 0 to 99 hours. If the timer is set at 0 hour, the heating system will activate immediately. Note that the timer is one time per use - the user sets the duration of the heating cycle, and how many hours from now the heating cycle begins. The timer does NOT repeat until reset.

**C** Massage System Button

Use this button to activate the massage system, which has a 30-minute auto-shutoff feature. The light above the massage system button displays red when activated.

**IMPORTANT:** Do not run the Massage system when the cover is attached. Air can accumulate inside the spa and cause irreparable damage and bodily harm.  
**NOTE:** Heat and massage system work together to create a warm massage experience.



**D** Celsius/Fahrenheit Toggle

The temperature can be displayed in either Celsius or Fahrenheit.

**E** Heat Button

Use this button to activate the heating system. When the light above the heat button is red, the heating system is activated. When the light is green, the water is at the set temperature and the heating system is at rest.

**NOTE:** If the heating system is activated the filtration system will automatically start.  
**NOTE:** After turning off the heating system the filtration system will continue to operate.

**F** Water Filter Button

This button turns the filter pump on and off. The light above the Water Filter Button displays red when activated.

**G** Temperature Adjustment Buttons

Pressing the Temperature Increase or Decrease buttons will cause the LED to flash. When flashing you can adjust to the desired temperature setting. If you hold these buttons down, the values will rapidly increase or decrease. The new and desired temperature setting will remain on the LED display for 3 seconds to confirm the new value.

**NOTE:** The default temperature is 95°F (35°C).  
**NOTE:** Temperature adjustment ranges from 68°F (20°C) to 104°F (40°C).

**H** Power-Saving Timer LED

- This LED flashing means you are setting the heating duration. The light will be on when the heating function starts to work.
- This LED flashing means you are setting the number of hours FROM NOW when the heater will activate. When the light is on, the Power-Saving Timer function is set.

**I** LED Display

- Once powered up, the LED displays the current water temperature automatically.
- After 72 hours of filtration (without using the power saving timer function), the pump will hibernate and flash "End" with the current water temperature. When the pump is hibernating both the heating and water filter functions are disabled. To re-activate the pump press lock/unlock button for 3 seconds.

**NOTE:** The water heat rate may change in the conditions below:  
 - When the outdoor temperature is below 59°F (15°C).  
 - If the cover is not in position when the heating function is activated.  
**NOTE:** To display the current water temperature, run the filter system for at least 5 minutes. The water temperature as tested by an external thermometer may vary from the temperature as displayed on the spa panel due to the different location in the spa where the measurement is being taken.

**Alarms**

	Causes	Reasons	Solutions
	The water flow sensors work without pressing the filter or heat button.	1. The water flow sensor flags didn't fall back into the correct position. 2. The water flow sensors are broken.	1. Unplug the pump, strike the side of the pump firmly (but not violently), and plug it back in. 2. Contact your local Bestway After Sales service point to get instructions.
	After starting or during the functions of filtering or/and heating, the water flow sensors do not detect water flow.	1. You forgot to remove the 3 stopper caps from inside the pool. 2. The filter cartridges are dirty. 3. Activate the filter or heat system and put your hand in front of the outlet pipe inside the pool to check if you can feel water flowing out. a. If no water flows out the water pump is broken. b. Water flows out but the alarm  appears, than the water flow sensors are broken.	1. Remove the 3 stopper caps before heating. Refer to Assembly section in the User's Manual. 2. Remove the filter set from inside the pool and push the filter or heat button. If no alarm appears, clean or change the filter cartridges install the filter set inside the pool. 3. Contact your local Bestway After Sales service point to get instructions.
	The pump's thermometer reads the water temperature below 40°F (4°C).	1. The water temperature is lower than 40°F (4°C). 2. If the water temperature is higher than 44.6°F (7°C), the pump's thermometer is broken.	1. The spa is not designed to operate with water temperatures lower than 40°F (4°C). Unplug the pump and only re-start the pump when the water temperature reaches 43°F (6°C). 2. Contact your local Bestway After Sales service point to get instructions.
	The pump's thermometer reads the water temperature over 119°F (48°C).	1. The water temperature is over 119°F (48°C). 2. If the water temperature is lower than 113°F (45°C), the pump's thermometer is broken.	1. The spa is not designed to operate with water temperatures greater than 104°F (40°C). Unplug the pump and only re-start the pump when the water temperature reaches 100°F (38°C) or lower. 2. Contact your local Bestway After Sales service point to get instructions.
	The pump's thermometer connections have issues.	1. The pump's thermometer connectors don't work properly. 2. The pump's thermometer is broken.	Contact your local Bestway After Sales service point to get instructions.
	The thermal cut-out cut off.	1. The ambient temperature is over 122°F (50°C) or the pump is directly under the sunshine. 2. The thermal cut-out is broken.	1. Unplug the pump, and put the pump in a dry, cool place. Only re-start the pump when the water temperature reaches 93.2°F (34°C) or lower. 2. Contact your local Bestway After Sales service point to get instructions.

**MAINTENANCE**

**NOTE:** Your spa will require additional air to be added from time to time. Changes in temperature from day to night will change the pressure in the spa and may cause a certain amount of deflation. Please follow the Assembly instructions and drain the spa before inflating to the accurate pressure needed.



**CAUTION:** YOU MUST ENSURE THE PUMP IS UNPLUGGED BEFORE BEGINNING SPA MAINTENANCE TO AVOID RISK OF INJURY OR DEATH.

## Filter Cartridge Maintenance

**NOTE:** To ensure your spa water stays clean, check and clean your filter cartridges every day follow the steps below.

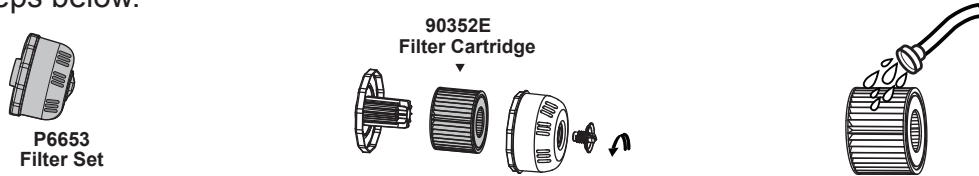

**NOTE:** We recommend changing your filter cartridges every week or, If the filter cartridges remain soiled and discolored, they should be replaced.

## Water Maintenance

Keeping your spa water clean and chemically balanced is necessary. Simply cleaning the filter cartridge is not enough for proper maintenance, we recommend you use pool chemicals to maintain water chemistry and chlorine or bromine tablets (do not use granules) with the chemical floater.

**NOTE: We recommend you take a shower before using your SaluSpa, as cosmetic products, lotions, and other residues on the skin can quickly degrade water quality.**

To use the chemical floater, please follow the below instruction.

### Using chemical tablets (not included):

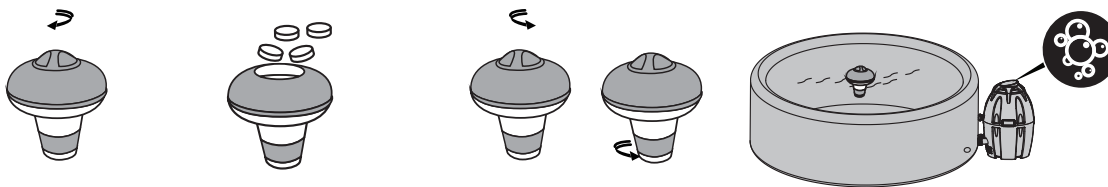

### Using chemical liquid (not included):



**NOTE:** Remove the chemical floater from spa when the spa is in use.

**IMPORTANT:** After performing chemical maintenance and before using the spa, use a test kit (not included) to test the water chemistry. We recommend maintaining your water as below table.

pH	Total Alkalinity	Free Chlorine
7.4-7.6	80-120ppm	2-4ppm

**NOTE:** Damage resulting from chemical imbalance is not covered by the warranty. Pool chemicals are potentially toxic and should be handled with care. There are serious health risks from chemical vapors and the incorrect labeling and storage of chemical containers. Please consult your local pool supply retailer for more information about chemical maintenance. Pay close attention to the chemical manufacturer's instructions. Spa damage resulting from misuse of chemicals and mismanagement of spa water is not covered by the warranty.

## Draining the Spa

**NOTE:** Drawings for illustration purpose only. May not reflect actual product. Not to scale.

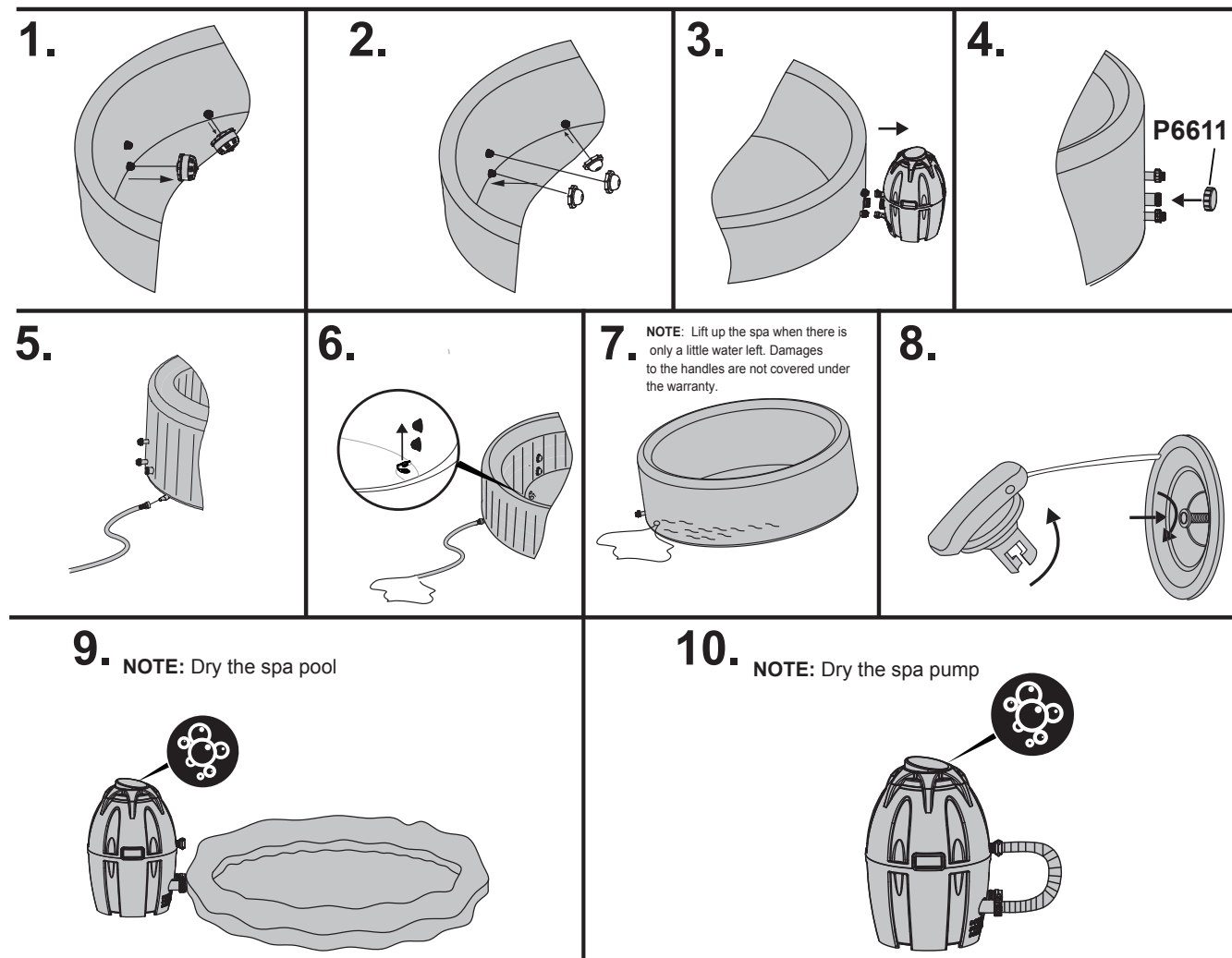

## Cleaning the spa

Detergent residues and dissolved solids from bathing suits and chemicals may build up on the spa walls. Use soap and water to clean the walls and rinse thoroughly.

**NOTE:** DO NOT use hard brushes or abrasive cleaners.

### Spa Repair

#### For inflatable cover.

If the spa is torn or punctured, use the provided heavy-duty repair patch.

1. Clean area to be repaired.
2. Carefully peel patch.
3. Press patch over area to be repaired.
4. Wait 30 seconds before inflation.

#### For Spa liner.

If the spa is torn or punctured, use the provided PVC repair patch and glue (not included) following these steps:

1. Clean and dry area to be repaired.
2. Cut the provided PVC patch to appropriate size.
3. Use glue (not included) to coat the one side of the newly cut patch. Make sure the glue is evenly distributed.
4. Wait for 30 seconds and then place the cut patch with glue over the damaged area.
5. Smooth out any bubble of air that may be trapped underneath, and press firmly for two minutes.
6. The product is once again ready for use. Repeat this process should further leaks occur.
7. Wait 30 minutes before inflation.



## Spa Storage

Make sure the spa and pump are completely dry. This is essential to extend the life of the spa. It is recommended you store the spa in its original package in a warm dry place.

**NOTE:** Plastic becomes brittle and susceptible to breaking when exposed to subzero temperatures. Freezing can severely damage the spa. Improper winterization of your spa can void your warranty.

## TROUBLESHOOTING

Coleman strives to provide the most trouble-free Spas on the market. If you experience any problems whatsoever, do not hesitate to contact Coleman or your authorized dealer. Here are some helpful tips to help you to diagnose and rectify some common sources of trouble.

Problems	Probable Causes	Solutions
Pump does not operate	<ul style="list-style-type: none"> <li>- Power failure</li> <li>- GFCI broken</li> </ul>	<ul style="list-style-type: none"> <li>- Check power source</li> <li>- Contact your local Bestway After Sales service point to get instructions</li> </ul>
Pump does not heat properly	<ul style="list-style-type: none"> <li>- Temperature set too low</li> <li>- Dirty Filter Cartridge</li> <li>- The thermal cut-out cut off</li> <li>- Spa is not covered</li> <li>- Heating element failed or fuse cutout</li> </ul>	<ul style="list-style-type: none"> <li>- Set to a higher temperature refer to section pump operation</li> <li>- Clean/replace the filter cartridge refer to section filter cartridge cleaning and replacement</li> <li>- Unplug the pump, and put the plug in a dry, cool place. Only restart the pump when the water temperature reaches 35°C (95°F) or lower</li> <li>- Attach the cover.</li> <li>- Contact your local Bestway After Sales service point to get instructions</li> </ul>
Massage System does not work	<ul style="list-style-type: none"> <li>- Air Pump is overheating</li> <li>- The massage system stops automatically</li> <li>- Air pump is broken</li> </ul>	<ul style="list-style-type: none"> <li>- Unplug the pump and wait two hours until the pump has cooled. Insert the plug and press the massage system button</li> <li>- Press the massage system button to reactivate</li> <li>- Contact your local Bestway Aftersales Service Center for instructions</li> </ul>
Pump adapters are not level with the spa adapters	<ul style="list-style-type: none"> <li>- One characteristic of PVC is that it changes shape, which is normal</li> </ul>	<ul style="list-style-type: none"> <li>- Elevate the pump with wood or another type of insulated material to bring the pump's adapters level with the spa's adapters</li> </ul>
Spa pool leakage	<ul style="list-style-type: none"> <li>- Spa is torn or punctured</li> <li>- Air valve is loose</li> </ul>	<ul style="list-style-type: none"> <li>- Use provided repair patch</li> <li>- Using soapy water, cover the air-valve to check if air is leaking, if so, use the provided wrench to fasten the air-valve following these steps:               <ol style="list-style-type: none"> <li>1. Deflate the SPA.</li> <li>2. With one hand, hold the backside of the air valve from the inner side of the spa wall and turn the wrench clockwise.</li> </ol> </li> </ul>
Water is not clean	<ul style="list-style-type: none"> <li>- Insufficient filtering time</li> <li>- Dirty Filter Cartridge</li> <li>- Improper water maintenance</li> </ul>	<ul style="list-style-type: none"> <li>- Increase filtration time</li> <li>- Clean/replace the Filter Cartridge (refer to Filter Cartridge Cleaning and Replacement section)</li> <li>- Refer to the chemical manufacturer's instructions</li> </ul>
Control panel not working	<p>The control panel has an auto-lock, which is activated after 5 minutes of inactivity. The LED display has one icon: . If the lock icon is highlighted, the control panel is locked</p>	<p>To unlock the control panel, press the  button for 3 seconds. If the control panel will not unlock, restart the pump – unplug and plug in the pump. If the problem persists, please contact your local Bestway Aftersales Service Center for instructions.</p>
GFCI test failed	There is a defect in your spa	Contact your local Bestway Aftersales Service Center and return the SPA.
What kind of chemicals should be used for water maintenance?	Please consult your local chemical supplier for information about chemical maintenance. Pay close attention to the chemical manufacturer's instructions.	
Water leaks from the adapters between the pump and spa	Insert the three stopper caps on to the spa's ports to prevent water from escaping and disconnect the pump. Check and make sure the seals are placed correctly inside the pump adapters. If the seals are missing or not installed correctly, please contact your local Bestway Aftersales Service Center for instructions. If the seals are correctly in place, reconnect the pump to the spa and hand-tighten the adapters.	



The product you have purchased comes accompanied by a limited warranty. Bestway® stands behind our quality guarantee and assures, through a replacement warranty, your product will be free from manufacturer's defects. The limited warranty is valid as follows:

**360 days** for the heater pump from the original date of purchase

**180 days** for the pool liner from the original data of purchase

**30 days** for hoses, fitting and accessory included in the package from the original date of purchase

To enact a warranty claim, please contact your local Bestway® After Sales Center at 1-855-838-3888 before sending any documents. They will provide full instructions of what is needed for your claim. Bestway® is not responsible for economic loss due to water or chemical costs.

Bestway® will not replace any products deemed to have been neglected or used outside of the owner's manual guidelines.

Bestway's warranty covers manufacturing defects discovered while unpacking the product or during use as recommended within the user manual. This warranty applies only to products which have not been modified by any 3<sup>rd</sup> parties. The product must be stored and handled in accordance with the technical recommendations.

The warranty does not cover damages caused by misuse, abuse, neglect, including, but not limited to collision, fire, use of incorrect voltage, excessive heat exposure, improper installation, improper wiring or testing or improper storage. Replacements and repairs don't extend the duration of the warranty. The Limited Warranty is valid for the period indicated above. The warranty start date is the date of sale shown on the original receipt/purchase invoice.

Please choose your Spa

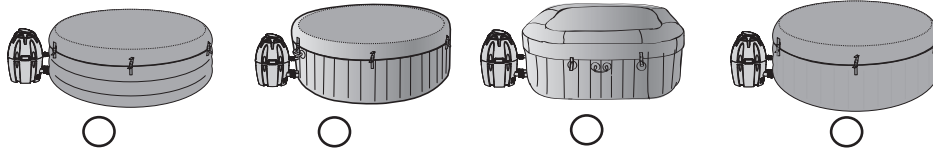

TO: Bestway® Service Department

Date of purchase: \_\_\_\_\_

Date: \_\_\_\_\_

Customer Code Number: \_\_\_\_\_

Website: [www.bestwaycorp.com](http://www.bestwaycorp.com) Toll-Free: 1-855-838-3888 Please provide your address details in full.

**Note:** Incomplete address details will result in delayed shipments.

Bestway® reserves the right to charge for redelivery of undelivered packages where the recipient is at fault.

**REQUIRED INFORMATION - PLEASE WRITE THE SHIPPING ADDRESS**

Name: \_\_\_\_\_ Address: \_\_\_\_\_

City: \_\_\_\_\_ State / Country: \_\_\_\_\_

Zip Code: \_\_\_\_\_ Retailer: \_\_\_\_\_

Mobile: \_\_\_\_\_ Telephone: \_\_\_\_\_

Fax: \_\_\_\_\_ E-mail: \_\_\_\_\_

Spa Pump Batch Number: \_\_\_\_\_ Spa Pool Batch Number: \_\_\_\_\_

Spa Pump Item Code: \_\_\_\_\_

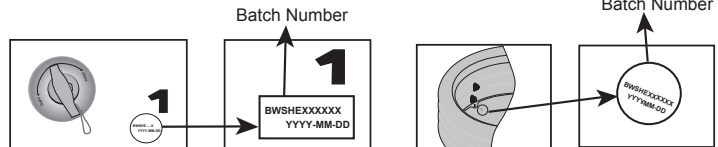
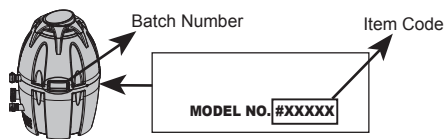

All drawings for illustration purpose only. Not to scale.

**Problem description**

- Spa leakage
- Water Filtration System not working
- Heating System not working
- Control panel shows a failure which cannot be solved
- Adapter leakage
- Massage System not working
- Pump leakage
- Other (Please describe)

Missing Part - Please use the code for the missing part. This can be found in the owner's manual.

**IMPORTANT:** ONLY THE DAMAGED PART WILL BE REPLACED, NOT THE COMPLETE SET.

Bestway® reserves the right to request photographic evidence of defective parts, or to require sending the item for additional testing.

In order to better assist you, we request all information you provide to be complete.

**FOR FAQ, MANUALS, VIDEOS OR SPARE PARTS, PLEASE VISIT OUR WEBSITE: [www.bestwaycorp.com](http://www.bestwaycorp.com).**